



<http://www.seventhwave.org/publications/net-energy-payback-and-co2-emissions-wind-generated-electricity-midwest>

Net Energy Payback and CO₂ Emissions from Wind-Generated Electricity in the Midwest

S.W. White and G.L. Kulcinski

December 1998

UWFDM-1092

FUSION TECHNOLOGY INSTITUTE

UNIVERSITY OF WISCONSIN

MADISON WISCONSIN

**Net Energy Payback and CO₂ Emissions from
Wind-Generated Electricity in the Midwest**

S.W. White
G.L. Kulcinski

Fusion Technology Institute
Department of Engineering Physics
University of Wisconsin-Madison
1500 Engineering Drive
Madison, WI 53706

December 1998

UWFDM-1092

Abstract

A net energy analysis and life cycle carbon dioxide emission analysis is performed on three wind-generated electrical power plants. The energy payback ratio is the amount of electrical energy produced over the lifetime of the power plant divided by the total amount of energy required to procure and transport materials, build, operate and maintain, and decommission the power plants. The energy payback ratio varies from a low of 17 for a two-turbine unit in Wisconsin to 39 for a 143-turbine wind farm in Southwestern Minnesota.

The CO₂ emissions for each power plant were calculated from the life-cycle energy requirement data. The normalized CO₂ emissions ranged from 9 to 20 tonnes of CO₂ per gigawatt-hour of electricity generated.

Table of Contents

Abstract.....	i
Table of Contents	ii
Table of Figures	ii
Table of Tables	iii
1. Introduction	1
2. Background	3
2.1 Description of Wind Projects Used in This Analysis	8
3. Approach and Methods	10
3.1 Literature Review of NEA's	10
3.1.1 Net Energy Analyses	10
3.1.2 CO ₂ Emissions.....	11
3.2 Energy Payback Ratio	11
3.3 CO ₂ Emissions	12
3.4 Background on the Wind Farms Included in This Study.....	13
4. Results & Discussion	20
4.1 Energy Analysis.....	20
4.2 CO ₂ Analysis.....	27
5. Conclusions	32
Acronyms and Abbreviations	35
Acknowledgements	36
References.....	37
Appendix A – Energy and Emission Factors.....	41
References – Appendix A	45
Appendix B - Buffalo Ridge Phase-I Wind Farm [1]	46
References - Appendix B.....	58
Appendix C - Buffalo Ridge Phase II	59
References – Appendix C	64
Appendix D - DePere Project	65
References – Appendix D.....	72

Table of Figures

Figure 1: Wind Electric Potential as a Percentage of Contiguous U.S. 1990 Total Electric Consumption [10]	4
Figure 2: Wisconsin Annual Average Wind Power [11] (see Table 1 for explanation of wind power classes. Generally, classes ≥ 3 are suitable for wind turbine applications).....	5

Figure 3:	Minnesota Annual Average Wind Power [11] (see Table 1 for explanation of wind power classes).	6
Figure 4:	Materials Procurement Dominates the Energy Requirements for Wind Farms .	22
Figure 5:	Materials Procurement Dominates the Energy Requirements for Wind Farms .	23
Figure 6:	BR-II Has a Significantly Higher Energy Payback Ratio Than Either BR-I or the DePere Wind Project.	25
Figure 7:	The Energy Payback Ratio Varies by More Than a Factor of Two Between Coal and Wind and Fusion Power Plants [35].	25
Figure 8:	Lifetime CO ₂ Emissions from the DePere Wind Project are Twice Those from BR-II.	28
Figure 9:	Wind Farm CO ₂ Emissions are Dominated by Materials Procurement.	29
Figure 10:	The CO ₂ Emission Rates of Electrical Power Plants are Dominated by Coal [35].	31
Figure C.1:	Tower Heights and Rotor Diameters of the Zond Z-750 series wind turbine generators - Z-46, Z-48, Z-50 [1]	59

Table of Tables

Table 1:	Classes of Wind Power Density at 10 m and 50 m [11]	5
Table 2:	U.S. Wind Electricity Generation Nameplate Capacity by State as of September 1996, Ref. [14] (Megawatts)	7
Table 3:	Comparison of Wind Data.....	8
Table 4:	Summary of Energy and CO ₂ Emission Factors for Power Plant Materials	15
Table 5:	Mass Requirements of Wind Turbine/Tower Assemblies (tonnes/unit).....	15
Table 6:	Examples of Input/Output Energy Intensity Factors Used for This Study [51]	18
Table 7:	Yearly and Lifetime Electricity Generation from Wind Power Plants	19
Table 8:	Comparison of Energy Investments for Energy Systems, by Process (GJ _{th} /MWe-Installed).....	21
Table 9:	Comparison of Energy Investments for Energy Systems by Process (GJ _{th} /GW _e h)	21
Table 10:	Comparison of CO ₂ Emissions from Energy Systems by Process (tonne CO ₂ /GW _e -Installed)	27
Table A.1:	Standard U.S. and Aluminum Smelter Electrical Distribution and Thermal and Net Conversion Efficiencies of Power Plants	41
Table A.2:	Initial Energy Payback Ratios	42
Table A.3:	Electricity Efficiency Average in U.S.....	42
Table A.4:	Energy Requirements for Transportation.....	42
Table A.5:	CO ₂ Emissions from Fuels and Electricity	43
Table A.6:	Air Emissions from the Standard U.S. and Aluminum Smelter Electrical Mix...	44
Table A.7:	Heating Values of Various Fuels	44
Table B.1:	Parameters for Buffalo Ridge Phase-I Wind Farm	46

Table B.2: Buffalo Ridge Phase-I Wind Project.....	47
Table B.3: Type, Length and Mass of Wire & Cable	48
Table B.4: Data for the Transportation of Wind Turbine Components	48
Table B.5: Projected Yearly Revenue for Buffalo Ridge Phase-I	50
Table B.6: Operation & Maintenance Energy Requirements Worksheet	51
Table B.7: Production History of Buffalo Ridge Phase-I.....	53
Table B.8: Lifetime and Annual Energy Investments for a Wind Power Plant (Buffalo Ridge Phase I)	56
Table B.9: Lifetime and Annual Emissions of CO ₂ for a Wind Farm (Buffalo Ridge Phase I)	57
Table C.1: Mass and Material Requirements of Zond Z-46 Wind Turbine Generators	60
Table C.2: Mass of Zond z-46 Wind Turbines at the Buffalo Ridge Phase II Wind Project	60
Table C.3: Data for the Transportation of Wind Turbine Components	61
Table C.4: Lifetime and Annual Energy Investments for a Wind Power Plant - (Buffalo Ridge Phase II)	62
Table C.5: Lifetime and Annual Emissions of CO ₂ for Buffalo Ridge Phase II Wind-farm	63
Table D.1: Mass and Material Requirements for Tacke 600e Wind Turbines at the DePere Wind Project.....	65
Table D.2: Mass of Tacke 600e Wind Turbines at the DePere Wind Project [2, 3].....	65
Table D.3: Data for the Transportation of Wind Turbine Components	66
Table D.4: The Energy Requirements to Construct the Two Turbine Wind Farm at DePere, Wisconsin.....	67
Table D.5: Costs and Energy Requirements for On-site Construction at DePere Wind Project	67
Table D.6: Site Specific Construction Direct Energy Consumption (not used in report) [10]	68
Table D.7: Electricity Generation Data at the DePere Wind Project.....	69
Table D.8: Lifetime and Annual Energy Investments for a Wind Power Plant - (DePere Wind Project)	70
Table D.9: Lifetime and Annual Emissions of CO ₂ for a Wind Farm (DePere Wind Project)	71

1. Introduction

The Earth's 14 warmest years since 1860 have occurred in the past two decades [1]. Perhaps even more alarming, the preliminary data shows that through eight months in 1998, the average global temperature is up by four-tenths of a degree over the average temperature of the previous record-setting year, 1997 [1].

Though "significant scientific uncertainties" exist concerning the role anthropogenic activities play in this warming trend [2], it is widely believed that carbon dioxide (CO₂) emissions from fossil fuel combustion are driving this recent warming trend. This theory is taken seriously enough that the United Nations has sponsored several conferences on climate change in the past decade. The most recent of these, the Third Conference of the Parties to the United Nations Framework Convention on Climate Change (UN FCCC) was held in Kyoto, Japan in December 1997.

The UN FCCC led to the Kyoto Protocol [3], which is an international agreement to reduce global CO₂ emissions to their 1990 levels by the years 2008-2012. The reduction of CO₂ emissions will vary for individual nations with some developed nations being required to reduce emissions below their 1990 levels and other developing nations being allowed to increase their emissions above 1990 levels. The Kyoto Protocol will become binding only after at least 55% of the participating nations (accounting for at least 55% of the total 1990 CO₂ emissions) ratify it [3]. The United States will be required to reduce its emissions to 93% of 1990 levels by the year 2020 [3]. As of early December 1998, the Protocol has been signed by President Clinton, but has not been ratified by Congress [4].

Meeting this goal will require a number of actions, one will be using less carbon-intensive fuels to generate electricity. In the Energy Information Administration (EIA) document “Impacts of the Kyoto Protocol on U.S. Energy Markets and Economic Activity” [5], it is forecast that in order to meet the CO₂ emission levels of “1990 minus 7%”, U.S. wind capacity will have to increase to 51 gigawatts (GW). This is 14 times higher than the reference case* of 3.5 GW of predicted capacity during that period and 31 times higher than the installed capacity in the U.S. in 1997 [6].

One popular misconception associated with renewable energy sources such as wind is that it does not emit any carbon dioxide. Proponents of renewable energy, such as World Watch have stated that “Wind, photovoltaics, and improved energy efficiency produce no carbon at all” [7]. In Wisconsin, the head of a statewide environmental group wrote to the local paper in support of wind power “Two high-tech wind turbines...are generating pollution-free electricity...” in DePere, Wisconsin [8].

Though these are nearly true statements when considering the electricity generation process only, both fail to address the larger picture. All the energy (much of it fossil energy) required to mine, transport and fabricate the materials of construction as well as to build and decommission the plants must also be included. When the total “cradle-to-grave” energy invested in renewable facilities is amortized over the useful lifetime of the plant, there will be a finite amount of carbon emissions though much smaller than coal plants. This paper will address both the energy requirements and CO₂ emissions associated with the life cycle of wind power plants.

* The reference case is an energy market without any enforced restrictions on carbon emissions, which would result in U.S. CO₂ emissions in 2020 being 33% above 1990 levels [5].

2. Background

The region of the country that will likely benefit the most from an increase in wind power will be the Midwestern Plains states. The Union of Concerned Scientists refer to Midwest wind resources in North Dakota, Minnesota and Kansas as “second to none in the world” [9]. Elliot et al. [10, 11], in two reports on U.S. wind resources, conclude that the Northern Plains states have the potential to provide a large percentage of the entire U.S. electricity based on 1990 consumption levels. Figure 1 shows the potential of wind to generate the electricity consumed in the lower 48 states in 1990. Figure 2 is a map showing the annual wind power potential throughout the state of Wisconsin and Figure 3 shows the average wind power of Minnesota. Areas that have wind energy potential that is suitable for wind turbine (nacelle) applications are those with a class 3 or greater annual average wind power [11].

This analysis focuses on wind generated electricity in the Midwest. As seen in Figure 1, Minnesota, Iowa and Wisconsin have the potential to provide nearly 20% of the entire U.S. 1990 electricity consumption from wind. While Wisconsin’s potential to make a large impact on the overall U.S. electrical market is relatively low, Minnesota has the potential to produce nearly 14% of U.S. electricity. The potential in North and South Dakota is ≈60%.

This report will focus on determining the energy payback ratio and lifetime emissions of CO₂ associated with wind-generated electricity at three separate projects; two in Minnesota and one in Wisconsin.

The Wisconsin project is a two-turbine experimental wind farm in DePere, Wisconsin that is known as the Wisconsin Low Wind Speed Turbine Project (referred to here as the

DePere Wind Project). This project is part of the Wind Turbine Verification Program (TVP), a national study co-sponsored by the Department of Energy (DOE) and Electric Power Research Institute (EPRI) that evaluates prototype advanced wind turbines at several sites in the U.S. [12]. The project in DePere was set up as a *low* wind speed site (average wind speeds of 13.6 miles per hour) and was the first utility wind project in Wisconsin.

Wind Electric Potential as a Percent of Contiguous U.S. 1990 Total Electric Consumption

Specifications: Wind Resource > Class 4 at 30m (>320W/m²), 30m hub height, 10D x 5D Spacing, 25% Efficiency, 25% Losses

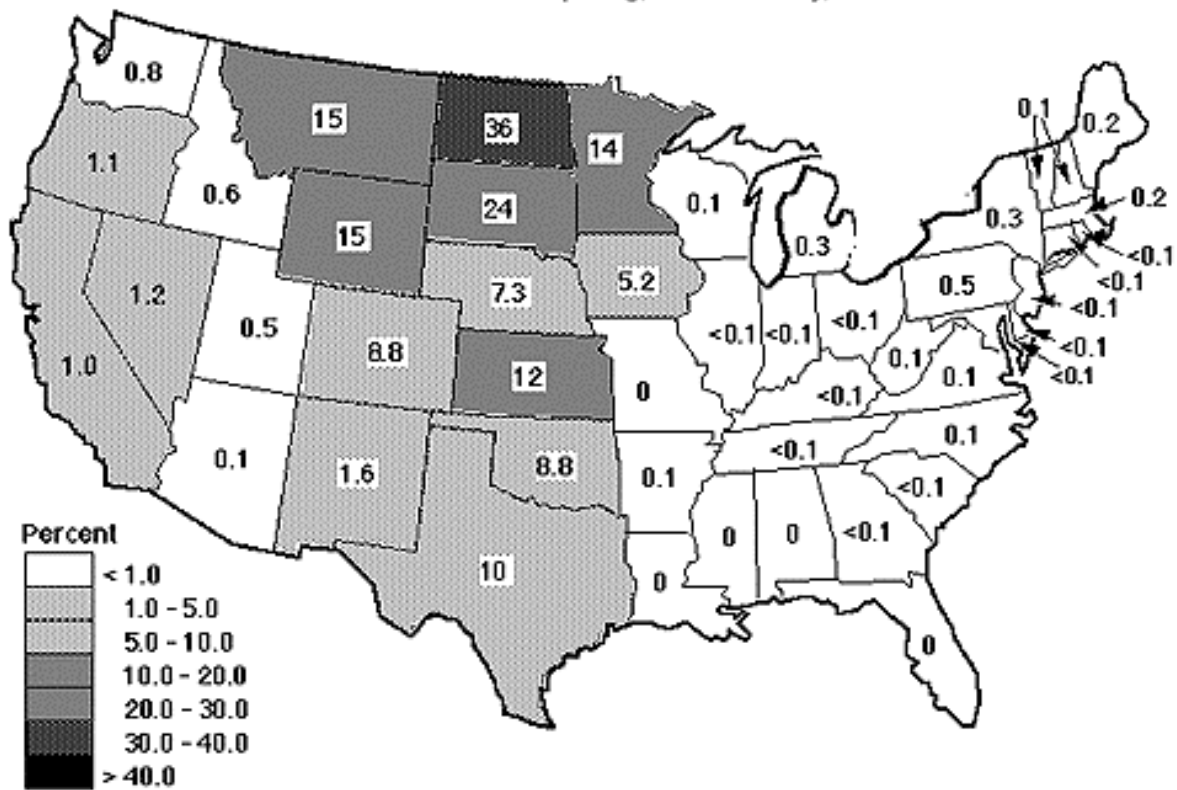

Excluded Land Area: 100% Environmental, 100% Urban, 50% Forest, 30% Agricultural, 10% Range

Figure 1: Wind Electric Potential as a Percentage of Contiguous U.S. 1990 Total Electric Consumption [10]

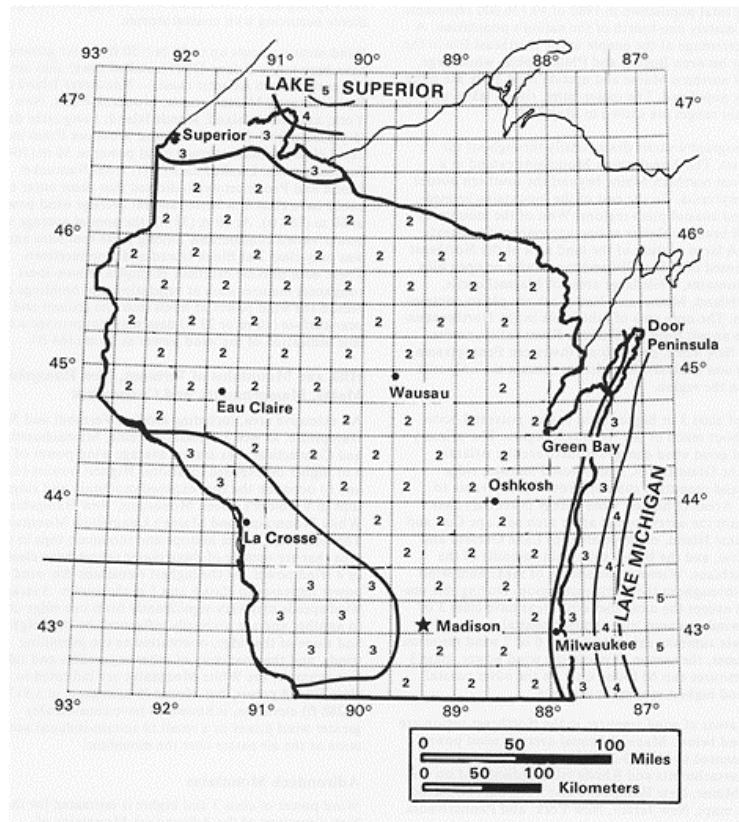

Figure 2: Wisconsin Annual Average Wind Power [11] (see Table 1 for explanation of wind power classes. Generally, classes ≥ 3 are suitable for wind turbine applications)

Wind Power Class ^b	10 m (33 ft)		50 m (164 ft)	
	Wind Power Density (W/m ²)	Speed ^c m/s (mph)	Wind Power Density (W/m ²)	Speed ^c m/s (mph)
1	0	0	0	0
2	100	4.4 (9.8)	200	5.6 (12.5)
3	150	5.1 (11.5)	300	6.4 (14.3)
4	200	5.6 (12.5)	400	7.0 (15.7)
5	250	6.0 (13.4)	500	7.5 (16.8)
6	300	6.4 (14.3)	600	8.0 (17.9)
7	400	7.0 (15.7)	800	8.8 (19.7)
	1000	9.4 (21.1)	2000	11.9 (26.6)

- ^a Vertical extrapolation of wind speed based on the 1/7 power law.
- ^b Each wind power class should span two power densities. For example, Wind Power Class = 3 represents the Wind Power Density range between 150 W/m² and 200 W/m². The offset cells in the first column attempt to illustrate this concept.
- ^c Mean wind speed is based on Rayleigh speed distribution of equivalent mean wind power density. Wind speed is for standard sea-level conditions. To maintain the same power density, speed increases 3%/1000 m (5%/5000 ft) elevation.

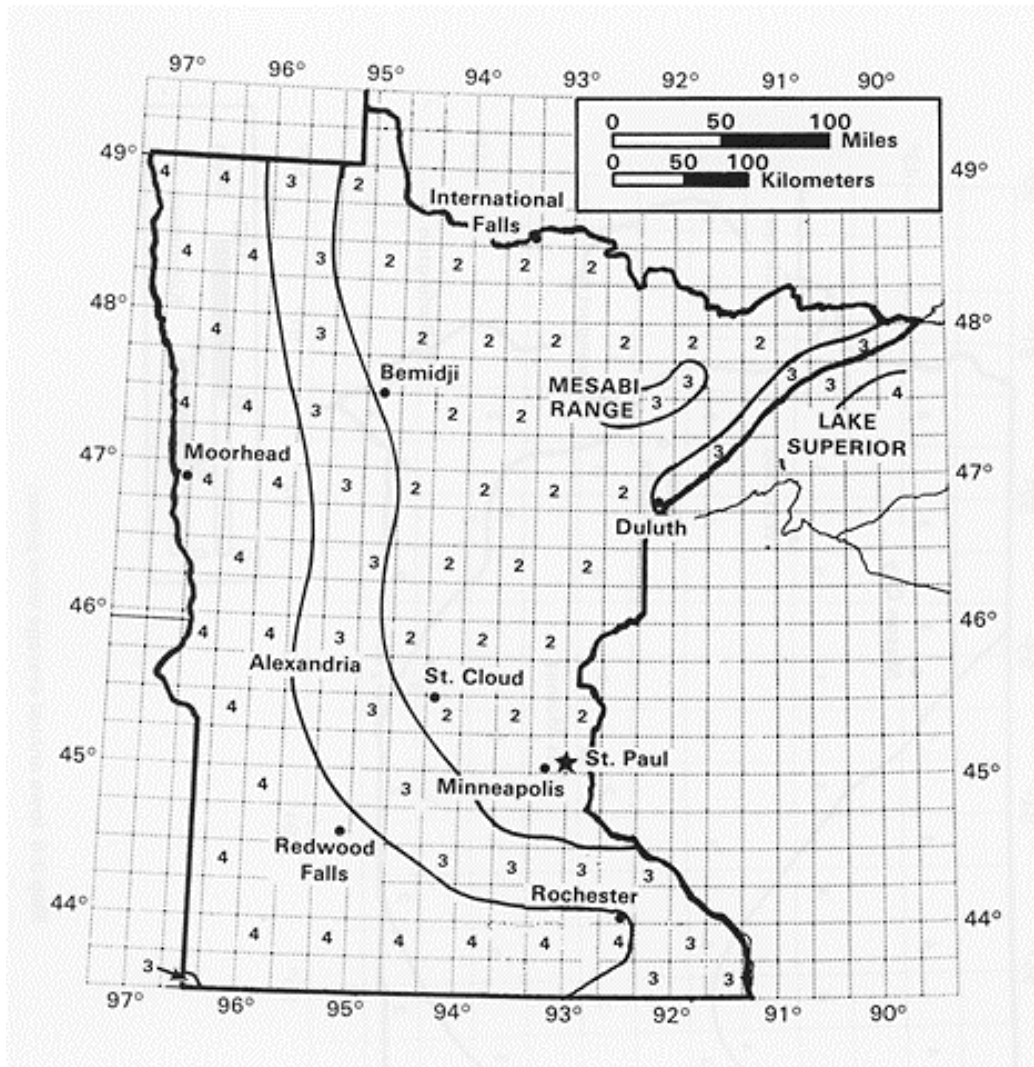

Figure 3: Minnesota Annual Average Wind Power [11] (see Table 1 for explanation of wind power classes).

Each site in the TVP is owned and operated by a different utility and features unique climatic and geographic characteristics.

The two sites in Minnesota are located on the Buffalo Ridge in the southwestern part of the state. The sites are known as Buffalo Ridge Phase-I (BR-I), a 73-turbine, 25 MW site, that is operated by LG&E and Buffalo Ridge Phase-II (BR-II), a 143 turbine, 107 MW site

that was built by Enron Wind Corporation. Both sites supply power to Northern States Power (NSP) utility of Minnesota.

Since 1983 the amount of electricity produced by wind in the United States has increased by a factor of 1,000 from three-gigawatt hours [13] (GWh) to 3,196 GWh in 1995 [6]. In 1995, 98% of all wind-generated electricity in the U.S. was in California (3,118 GWh), while only 2% was in Minnesota (58 GWh), and very little in Wisconsin (0 GWh) and Iowa (0.12 GWh) [6].

In 1996, the online capacity of wind power in the United States was 1,718 megawatts (MW), with 95% of that in California (1,635 MW) and 2% in Minnesota [14] (see Table 2). At that time, another 659 MW of wind power was planned for the U.S., 442 MW of which was to be built in the midwestern states of Iowa, Minnesota, and Wisconsin. As of December 1998, at least 107 of the 400 MW planned for Minnesota were in operation. When all of the planned projects come online, the percentage of wind generation capacity in Iowa, Minnesota and Wisconsin will have risen to nearly 20% of the total U.S. wind capacity.

State	Online	Planned	Total
California	1,635	9	1,644
Iowa	2	32	34
Minnesota	26	400	426
Wisconsin	0	10	10
Other States	55	208	263
Total	1,718	659	2,377

2.1 Description of Wind Projects Used in This Analysis

Three wind farms were analyzed for this report. One site is in DePere, Wisconsin and two are in Southwestern Minnesota along the Buffalo Ridge near Lake Benton, Minnesota. The characteristics of the three wind sites are listed in Table 3.

When this analysis was started in June 1997, it was intended that the two-turbine project at DePere, Wisconsin would be the primary focus. At that time, the two-turbine wind project was slated to be constructed in August 1997. However, there were a number of delays and the erection date for the towers and turbines was pushed back to September, November, and finally completed in January 1998.

Table 3: Comparison of Wind Data			
	Buffalo Ridge Phase Ia	Buffalo Ridge Phase II^b	DePere^c
Turbine Manufacturer & Model	Kenetech KVS-33	Zond Z-46	Tacke 600 ^e
First Year of Operation	1994	1998	1998
Rated Power per Turbine (kW _e)	342.5	750	600 ^d
Gross Rated Power per Turbine (kW _e)	410		629 (max)
Number of Turbines per Power Plant	73	143	2
Rated Power Plant Output (MW _e)	25	107.25	1.2
Predicted Life of Nacelle (years)	30 ^b	25	20
Capacity Factor (Projected)	33%	35%	31%
Capacity Factor (Actual)	24% ^a	Unavailable	Unavailable
Tower Height (feet)	120 ft	159 ft	197 ft
Rotor Diameter	108 ft	151 ft	151 ft
Average Wind Speed of Site			13.6 mph ^c

^a Ref. [15]

^b Ref. [16]

^c Ref. [17]

^d @ 13.5 meters/second, Ref. [17]

The Wisconsin site is located in the Town of Glenmore near the City of DePere. This site consists of two Tacke 600e turbines that have a combined 1.2 MW of power capacity. These turbines are operated by Wisconsin Public Service Corporation (WPSC) and are co-owned with Madison Gas and Electric, Alliant Energy (formerly Wisconsin Power and Light), Wisconsin Electric Power Co., EPRI and the DOE/EPRI TVP program.

During the delays, the need to expand the scope of this analysis became evident. The primary reason was that the DePere Wind Project would not be able to provide a full year of actual electricity generation data in the period of this study. To extrapolate this data, a full year is needed to account for the wind patterns of each season. Also, a small project such as this (two turbines) would not provide a large enough statistical database. Therefore, it was decided to concentrate on the two Minnesota projects.

The two Minnesota wind farms are in existence because of Minnesota state legislation. In the early 1990's, the Minnesota legislature passed a law that required Northern States Power (NSP) to install 425 MW of wind power capacity by the end of 2002 [18]. This mandate was done in exchange for a permit allowing the utility to add dry cask storage of nuclear waste at their Prairie Island site [18].

The first phase at Buffalo Ridge (BR-I) wind farm consists of 73 turbines near Lake Benton, which began generating electricity and data in March 1994 [15]. Buffalo Ridge Phase-I has a total installed capacity of 25 MW, and was built and operated by Kenetech Windpower, Inc. After developing problems with the KVS-33 turbines, Kenetech went bankrupt and LG&E, Inc. of Costa Mesa, California assumed operations of BR-I.

Phase II of the Buffalo Ridge (BR-II) wind farm was added to the present analysis even though all the data was not available since it was a current project. This phase consists of 143 Zond Z-46 Wind Turbines, which have a combined capacity of 107.25 MW. Enron Wind Corporation (formerly Zond Energy Systems) of Tehachapi, California operates this wind plant, which is also located near Lake Benton. Phase II construction was completed in July 1998 and began operating shortly after [19]. The DePere Wind Project was kept in this analysis because of the project's proximity to the sponsors of this report and the access granted to construction and operational data by the project's operators and constructors.

3. Approach and Methods

3.1 Literature Review of NEA's

One of the main purposes of this analysis is to couple the net energy analysis of electricity producing technologies with a life-cycle analysis of the CO₂ emissions. The two primary products of this analysis are the energy payback ratio (EPR) and the CO₂ emission factor of each technology. The methods used to determine these results are explained below.

3.1.1 Net Energy Analyses

There have been several papers which have included net energy analyses of wind-generated power. The two earliest papers from the U.S. were by Perry et al. [20] and Devine [21] during 1977. More recently, the NEA's involving winds have been performed outside of the United States. There have been three German NEA's involving wind [22-24], two Danish reports [25, 26] and two reports from Japan [27, 28].

3.1.2 CO₂ Emissions

Analyses of the life-cycle emissions of CO₂ associated with wind generated electricity were included in papers by Friedrich [29], Lewin [30], San Martin [31], Uchiyama [32], Van de Vate [33], and Yasukawa [34]. Our results will be compared to these analyses in Section 4.2.

3.2 Energy Payback Ratio

The concept is straightforward. First, all the useful energy produced by an electrical power plant over its lifetime is determined. Second, the total amount of energy needed to gather all the fuel and construction materials, and the energy needed to construct, operate, and decommission the plant is calculated. Third, the energy payback ratio (EPR) is determined by the relationship in Equation 1:

$$EPR = \frac{\mathbf{E}_{n,L}}{\left(\mathbf{E}_{mat,L} + \mathbf{E}_{con,L} + \mathbf{E}_{op,L} + \mathbf{E}_{dec,L}\right)} \quad (\text{Equation 1})$$

where, $\mathbf{E}_{n,L}$ = the net electrical energy produced over a given plant lifetime, L.

$\mathbf{E}_{mat,L}$ = total energy invested in materials used over a plant lifetime L.

$\mathbf{E}_{con,L}$ = total energy invested in construction for a plant with lifetime L.

$\mathbf{E}_{op,L}$ = total energy invested in operating the plant over the lifetime L.

$\mathbf{E}_{dec,L}$ = total energy invested in decommissioning a plant after it has operated for a lifetime L.

In practice, the output energy calculation is easy but the determination of the input energy is not. Two approaches to calculate the input energy have been used in the past. The Input/Output (I/O) method relies on the simple concept that to a large degree, the more expensive an item or service, the larger the energy content of that item or service. With the use of energy I/O matrix, this approach allows one to calculate the energy input of a process once the cost of goods and service inputs are known. Details of the I/O method are discussed in previous publications [35, 36].

The second approach is the Process Chain Analysis (PCA), which addresses each process contributing to the useful lifetime of the power plant. The PCA method measures the materials and energy flows of each process, translates material flows into energy via an embodied energy factor, and sums the total energy requirements. Because this approach is very specific to the types of fuels used in each process, it greatly aids the calculation of CO₂ emission rates. Details of the PCA method are discussed in previous publications [35, 36].

3.3 CO₂ Emissions

Every time energy (thermal or electrical) is used to make a product, some waste products are released to the environment. In the best case, this waste product is just heat. In most cases, the waste products include greenhouse gases such as CO₂, NO_x, CH₄, etc. The pollutants emitted during the generation of electricity depend on whether the power plant is fueled by coal, uranium, or the wind. In this analysis, the CO₂ emission factor for electricity was based on the average of the U.S. electrical mix of 1996 as shown in Appendix A.

Once the EPR is determined, one can use the components of energy input to calculate the emission of a specific pollutant (i. e., CO₂ per kg of fuel, metal, or concrete for each GW_ey of net electricity sent to consumers). This is stated mathematically for CO₂ in Equation 2:

$$\frac{\text{kg} \cdot \text{CO}_2}{\text{GW}_e \text{y}} = \frac{\sum_i \left(\frac{\text{kg} \cdot \text{CO}_2}{\text{kg} \cdot \text{M}_i} \right) \sum \text{kg} \cdot \text{M}_i}{\text{E}_{n,L}} \quad (\text{Equation 2})$$

where $\text{E}_{n,L}$ = the net electrical energy produced over a given plant lifetime, L

$\frac{\text{kg} \cdot \text{CO}_2}{\text{kg} \cdot \text{M}_i}$ = kg of CO₂ emitted per kg of material i produced

$\text{kg} \cdot \text{M}_i$ = kg of material i needed to construct and/or operate the plant for life L.

Where applicable, the energy inputs are broken down into both thermal (TJ_{th}, GJ_{th}) or electrical (TJ_e, GJ_e, GW_eh) energy. This was done to account for the different emission factors for thermal fuels such as diesel, gasoline, or coal and electricity. The total energy is accounted for in terms of thermal energy and is the sum of the electrical energy divided by the average electricity efficiency in the United States (36.9%, see Appendix A) and the thermal energy.

3.4 Background on the Wind Farms Included in This Study

The data for the three wind plants analyzed here was compiled from various sources. The relevant parameters of each wind farm are listed in Table 3. For BR-I, the entire power plant is designed to produce a maximum of 25 MW_e. Individually, each of the 73 wind

turbines has a rated power of 342.5 kW_e. It is predicted that each nacelle will last for 25 years. The predicted capacity factor for the turbines, according to the manufacturers, was 33% [15]. So far, with four years of operation, the BR-I wind farm has only maintained a capacity factor of 24%.

For BR-II, the power plant is designed to produce 107.25 MW_e. Individually, each of the 143 wind turbines has a rated power of 750 kW_e. It is predicted that each nacelle will last for 25 years. The predicted capacity factor for the turbines is 35%. So far, there is not enough data to establish the actual capacity factor.

The DePere Wind Project is designed to produce 1.2 MW_e. Each of the two wind turbines has a rated power of 600 kW_e. While it is predicted that each nacelle will last for 20 years, the WPSC only has a five-year lease agreement with the landowner and an equal-length approval from the township [17, 37]. This is due to their involvement in the DOE/EPRI TVP, in which the turbines are deemed experimental. The length of the experiment is five years. The predicted capacity factor for the turbines is 31% and at the time of this study, there was not enough data to establish the actual capacity factor.

The difference in the projected capacity factors of DePere and both Buffalo Ridge sites has to do with the wind resource at each site. The Buffalo Ridge average wind speed is higher than the DePere site.

In calculating the energy requirements and CO₂ emissions associated with plant materials, the mass of each material was multiplied by the corresponding energy and CO₂ emission factor for each. The energy and CO₂ emission factors for materials from the wind plants are listed in Table 4 and detailed in Reference 35.

Element or Alloy	Energy (GJ/tonne)	CO₂^a (kg CO₂/tonne material)
Concrete^b	1.4	520
Copper^c	131	7,446
Fiberglass^d	13	804
Steel - Carbon/Low Alloy^e	34	2,473
Steel - Stainless^e	53	3,275

^a All CO₂ emissions were calculated from energy data.

^b Ref. [38]

^c Ref. [39]

^d Ref. [40]

^e Ref. [41]

The material requirements from each wind plant are listed in Table 5. This data was collected through official project data and personal communications with representatives of the projects. Table 5 shows the mass of each wind turbine/tower-assembly by component.

	Buffalo Ridge Phase I^a	Buffalo Ridge Phase II^b	DePere^c
Nacelle Make and Model	Kenetech KVS-33	Zond Z-46	Tacke 600e
Nacelle	5.9	19.3	33.0
Rotor/Blades	6.8	13.2	6.0
Towers	19.7	56.6	71.0
Foundation - Concrete	136.1	376.4	394.0
Foundation - Rebar	NA	9.1	12.2
Copper - Wire	0.1	1.4	0.8
Control Cabinet	0.5	NA	0.3
Total Mass (tonnes/unit)	169.0	476.0	517

^a Ref. [42]

^b Ref. [43]

^c Ref. [17, 44]

More detailed data on the total mass requirements for each wind project can be seen in Appendices B, C, and D.

In the analysis, the energy requirements for wind farm construction include transportation of the components to the construction site, and the actual onsite construction. The distances and related data for transporting the wind turbine and tower components from the manufacturing site to the wind plants are listed in Appendices B, C, and D. The manufacture site data for each component of BR-I, BR-II and DePere was obtained from LG&E [45], Zond [46], and Huron Wind Power [47] respectively. The distances between these sites were calculated using the Mapquest™ map-generating program [48], which can determine the distances between two towns or addresses. The energy requirements per transportation mode are listed in Appendix A. To calculate the CO₂ emissions from component transportation, it was assumed that all energy requirements were from diesel fuel. The diesel fuel emission factor was then multiplied by the amount of fuel that would be needed to provide this energy. Heating values for diesel and other fuels are also listed in Appendix A.

The energy requirements to construct the respective wind plants were only available for the DePere Wind Project [49]. Construction data for BR-I and BR-II was not available at the time of this report. Therefore, the data used for the analysis of BR-I and BR-II was scaled from data to construct the DePere wind farm. This data is located in Appendix D. An example of how the on-site construction energy requirements for the turbine/tower-assemblies of BR-I were scaled from the DePere data is shown in Equation 3:

$$\left(\frac{\# \text{ of turbines BR - I}}{\# \text{ of turbines DePere}} \right) * \left(\frac{\text{Mass of 1 BR - I turbine/tower assembly}}{\text{Mass of 1 DePere turbine/tower assembly}} \right) = \frac{73}{2} * \frac{169}{517} = 11.9$$

(Equation 3)

The energy requirements for turbine/tower-assemblies at BR-II were scaled in a similar manner.

The turbine/tower assemblies at the DePere site are both significantly larger in mass than those at BR-I and have a higher rating (600 to 342.5 kW_e) as well. The mass and material requirements are listed in Table 5. Greater detail of these requirements can be found in Appendices B-D. In calculating the CO₂ emissions from construction activities, it was assumed that all energy came from diesel fuel.

The construction data for the DePere wind project came in the form of economic costs, as did the operation and maintenance (O&M) data. Only data for DePere and BR-I wind projects O&M was made available. All costs were translated into 1995 dollars, using the Consumer Price Index [50].

The cost data for construction and O&M is available in Appendix B for BR-I and Appendix D for the DePere Wind Project. The energy requirements for both of these processes were calculated from the cost data using the I/O method. Examples of some I/O factors used in this study are given in Table 6. Carbon dioxide emissions were calculated by assuming that all O&M energy was in the form of diesel fuel. The energy units were converted to gallons of diesel, which in turn were multiplied by the CO₂ emission factor for the fuel (see Appendix A).

Wind Process Name	I/O Sector Name	Total (Btu_{th}/1977\$)	Total (MJ_{th}/1977\$)
Craning	Hoists, Cranes	30,233	31.90
Electrical Grounding	New Construction, Electric Utility	30,648	32.33
Labor	Misc. Business Services	10,000	10.55
Local Equipment Rental	Construction Machinery	34,534	36.43
Lodging and Food for Employees	a) Eat & Drink Places	23,620	24.92
	b) Hotels	33,939	35.81
	Average a & b	28,780	30.36
Nacelle O&M	Auto Repair ^a	22,055	23.27

^a Based on 1977 dollars, from Spreng [51]

The O&M energy requirements for BR-II were calculated from the DePere data scaled on the ratio of number of turbines (143/2) times O&M energy requirements for DePere. Carbon dioxide emissions for BR-II were calculated similarly.

Data on the energy requirements to decommission the three wind plants was not available at the time of this study. For this reason, an assumption was made that it would take approximately the same amount of energy to completely dismantle the turbine/tower-assembly as it would to erect and assemble the nacelles and towers. At the same time, it is assumed that while the nacelles with all their moving parts will only last between 20-30 years, the towers that support the nacelles will last longer than that. For this analysis, it is assumed that a tower will last for the life of two wind turbines. The only energy requirements essential to assemble the second nacelle will involve removing the old and placing the new one on top of the tower, as well as necessary electrical hook-up. For this reason, it is assumed that the total energy required to dismantle one turbine will be half the

energy required for on-site assembly, since the energy required for dismantlement can be amortized for two turbines. It is also assumed that the fuel used to dismantle the turbines will be diesel.

The electricity generation projections for each wind farm are listed in Table 7. Only BR-I has sufficient electrical generation data to extrapolate the lifetime electricity production. The yearly electricity production data for BR-I is a four-year average from actual data. Yearly electricity production data for BR-II and DePere Wind Projects are based on forecasts using the projected capacity factors of each. The lifetime electricity productions for all three wind farms are projections based on yearly electricity production and the manufacturers' predicted lifetime for each turbine. When comparing the results of the three wind farm projects, it must be considered that the data for BR-I is based on actual electrical generation data, while the other two are merely forecasts. This is especially true in light of the fact that the actual capacity factor of BR-I is nine percentage points less than the projected capacity factor (see Table 3).

Table 7: Yearly and Lifetime Electricity Generation from Wind Power Plants		
	Yearly Electricity Production (GWh)	Projected Lifetime Electricity Production
Buffalo Ridge Phase-I	53.5 ^a (actual)	1,338 ^b
Buffalo Ridge Phase-II	330 ^c (projected)	9,900 ^d
DePere Wind Project	3.3 ^e (projected)	65 ^f

^a Based on a four-year average for the period June 1994 to May 1998, Ref. [15, 52]

^b Predicted 25-year lifetime of nacelle, Ref. [15]

^c Based on a forecast using projected capacity factor (35%), Ref. [43]

^d Predicted 30-year lifetime of nacelle, Ref. [53]

^e Based on a forecast using projected capacity factor (31%), Ref. [17]

^f Predicted 20-year lifetime of the nacelle, Ref. [17]

Electricity generation data for BR-I is available for the period March 1994 through July 1998 (see Appendix B) [15, 52]. The yearly average of electricity produced at the 25 MW_e wind farm is the average of the four-year period from June 1994 through May 1998. The capacity factor is calculated by dividing the yearly average of electricity (53.5 GW_eh) by the amount of electricity that would be generated if the power plant produced at its rated capacity for a full year (25 MW_e*8760 hours/year = 219 GW_eh). The actual capacity factor of BR-I is 24%.

Lifetime electricity production for BR-II and DePere was calculated in a similar manner as described above. The projected lifetime electricity production is equal to the predicted lifetime in years of the nacelle multiplied by 8760 (hours per year), by rated power (MW_e), and by the projected capacity factor (%). This result serves as the numerator in Equation 1 and the denominator in Equation 2 as detailed in Sections 3.2 and 3.3 respectively.

4. Results & Discussion

4.1 Energy Analysis

The results of the energy analyses as shown in Tables 8 and 9 are normalized in two ways. In Table 8, the energy requirements are normalized per megawatt of installed-capacity for the entire wind farm. Table 9's data is normalized per gigawatt-hour of electricity generated. There are advantages of normalizing the data in both ways.

Normalization per installed-megawatt eliminates differences in the location of each wind turbine. Some sites have a better wind resource, which serves as an advantage to any

wind turbine located there. This is shown by the fact that both BR-I and BR-II to have similar energy requirements per installed MW though when normalized per unit of electricity produced, BR-II has a significant advantage over BR-I. The energy requirements per installed MW at DePere are $\approx 25\%$ greater than either Buffalo Ridge site due to the economy of scale.

Process	Buffalo Ridge Phase I	Buffalo Ridge Phase II	DePere
Nacelle Make	Kenetech	Zond	Tacke
Materials Production	4,003	5,341	8,158
Materials Transportation	604	261	400
On-site Construction & Assembly	612	855	1,069
Operation & Maintenance	2,985	1,636	1,363
Decommissioning & Dismantlement	306	427	534
Total	8,510	8,521	11,524

Process	Buffalo Ridge Phase I	Buffalo Ridge Phase II	DePere
Materials Production ^a	75	58	150
Materials Transportation	11	3	7
On-site Construction & Assembly ^b	11	9	20
Operation & Maintenance	56	18	25
Decommissioning & Dismantlement	6	5	10
Total	159	92	212
EPR	23	39	17

^a For details, see the respective Appendices.

^b All data is normalized from the DePere data. See Equation 3 in Section 3.4.

Normalizing the data per gigawatt-hour produced factors in each site's wind resource, wind turbine capacity factors, as well as the conversion efficiencies of the nacelles. This

method of normalization also coincides with economic analyses, which standardly measures cost per unit of electricity generated (e.g. GWh). The rest of this analysis and all the figures refer to data normalized per $\text{GW}_{\text{e}}\text{h}$, unless otherwise noted.

As seen in Figure 4, the majority of the energy requirements for all three wind projects are related to materials production. This is highlighted in Figure 5, which shows that materials production is responsible for a large share of the energy requirements of BR-I (47%), BR-II (63%) and DePere Wind Project (71%). As illustrated in Figure 4, the normalized energy requirements embodied in the DePere wind-turbine/tower-assembly materials is 50% higher than the total energy requirements of BR-II and nearly as much as the total for BR-I. The larger mass of materials is the primary reason for the greater share of energy going toward materials at DePere.

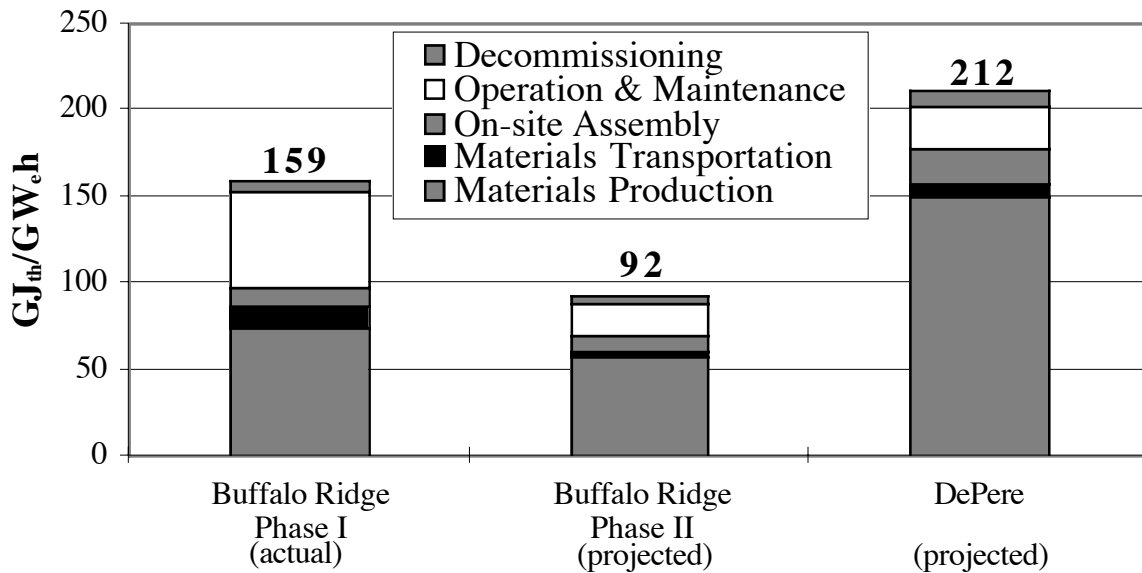

Figure 4: Materials Procurement Dominates the Energy Requirements for Wind Farms

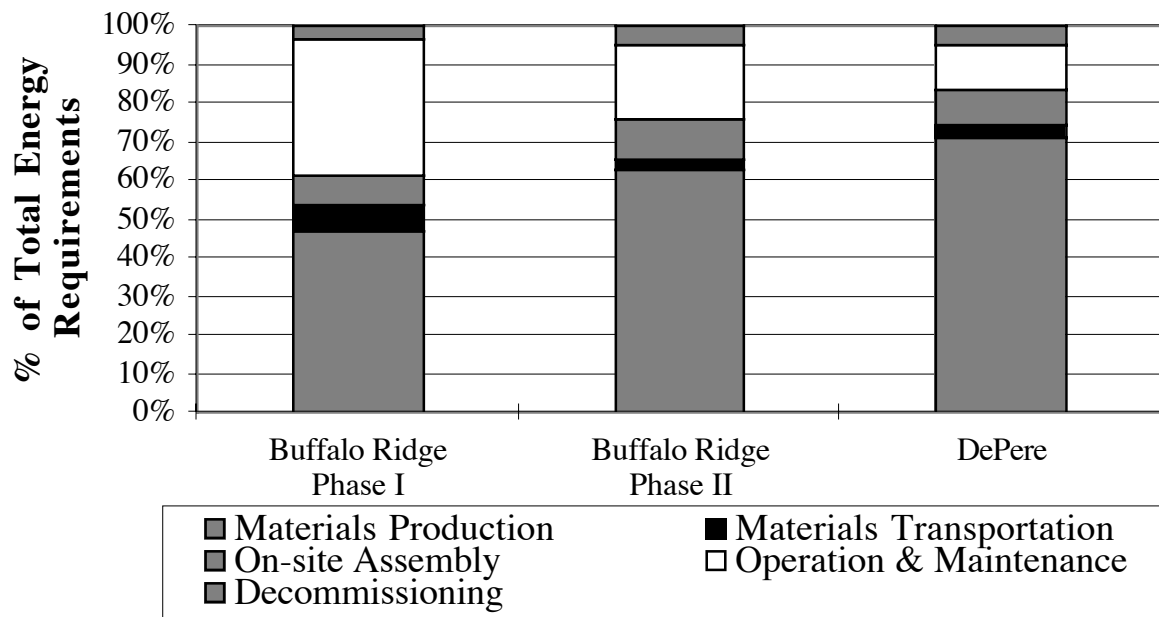

Figure 5: Materials Procurement Dominates the Energy Requirements for Wind Farms

The energy requirements for O&M comprise $\approx 35\%$ of the total energy at BR-I. The processes involved in O&M are similar for the three wind farms. Wind farms are modular by nature and each nacelle has numerous moving parts. Maintaining a wind farm is similar to maintaining a fleet of cars. Each nacelle will need to be monitored and serviced regularly, which will require significant amounts of lubricating oil and fuel for service vehicles. Service vehicles may require long drives for service personnel because of the typical remoteness of wind turbines. The primary reason that BR-I has the highest energy requirements of the three wind farms is due to the lower capacity factor (24% actual value compared to projected values of 35% and 31% for BR-II and DePere respectively), and lower rated-power capacity (330 MW compared to 750 and 600 MW for BR-II and DePere respectively). The processes and energy expenditures for a 330 kW nacelle are not any different than one that is 750 kW. Both BR-I and BR-II have full-time crews on site to take care of all O&M, while DePere O&M is taken care of on an annual schedule and an “as needed” basis.

The energy requirements for material transportation are highest for BR-I. This is due in part to the lower capacity factor, but is also due to the longer distance the nacelle was transported. The BR-I nacelles were machined in Milwaukee, Wisconsin shipped by truck to Livermore, CA where they were assembled and trucked again to Lake Benton, MN. The nacelles of BR-II and DePere were machined and assembled in similar locales before being transported to the wind site. Though DePere's Tacke nacelles came from Germany, both ship and rail transported them, which are less energy-intensive modes of transport. Transportation details of the projects are in Appendices B, C and D.

Plant construction energy requirements are highest for the DePere Wind Project. This is due to the larger mass of the Tacke components and taller, heavier towers that are needed to tap into the wind resource. At the same time, the scales of economy were worse for DePere than either of the larger Buffalo Ridge projects.

A summary of the overall energy payback ratios (EPR) is given in Figure 6. The results of this study found the DePere Wind Project produces 17 times more energy in electricity than is required to make it over the lifetime of the plant. The EPR is somewhat higher for Buffalo Ridge Phase-I (23) and highest for Buffalo Ridge Phase-II (39).

For comparative purposes, Figure 7 shows the EPR of BR-I compared to coal, nuclear fission and fusion technologies. Wind compares favorably with coal and fission and is slightly lower than the projected energy payback of nuclear fusion. It must be noted that the fusion results are based on a design and not an operating power plant.

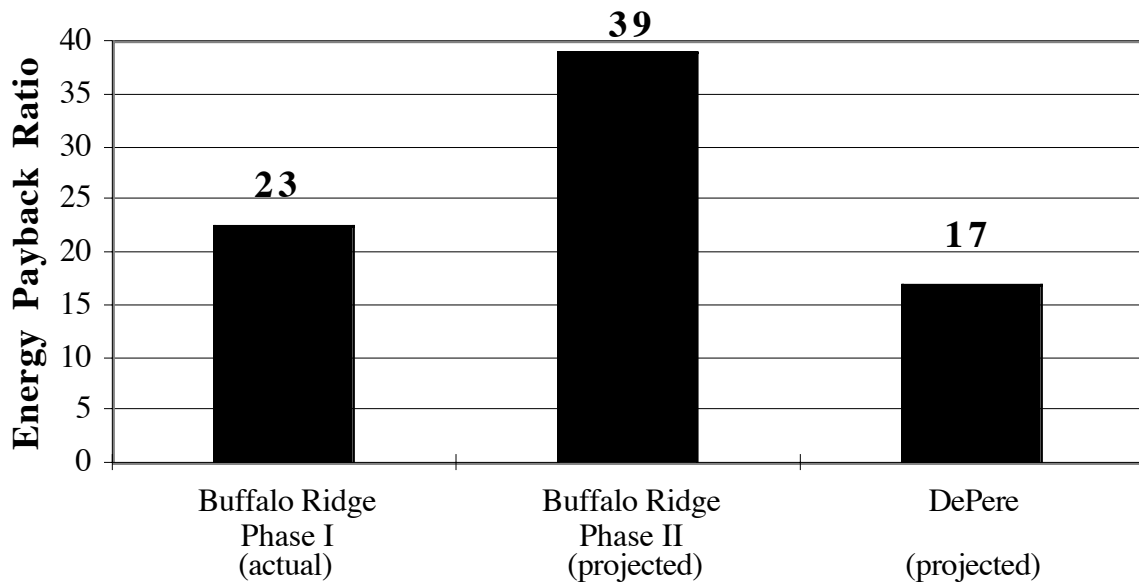

Figure 6: BR-II Has a Significantly Higher Energy Payback Ratio Than Either BR-I or the DePere Wind Project.

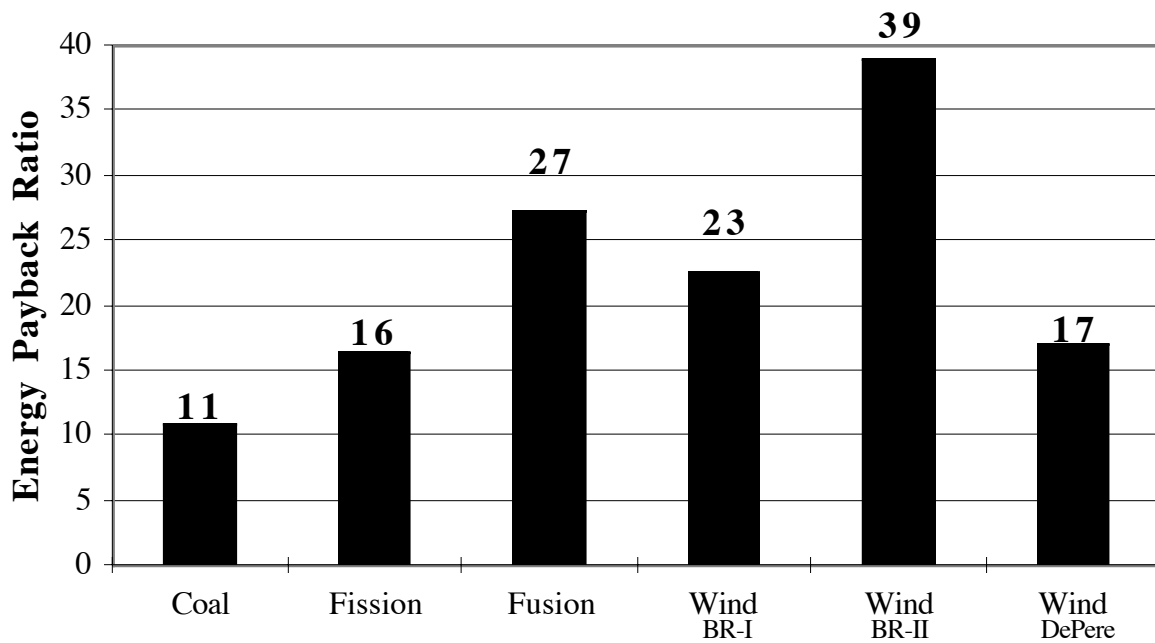

Figure 7: The Energy Payback Ratio Varies by More Than a Factor of Two Between Coal and Wind and Fusion Power Plants [35].

A fair comparison of wind power plant technologies to baseload technologies would include energy storage for wind. Wind and other intermittent technologies will never be able to fully compete with baseload technologies without a means to store energy for the times when they are not directly producing electricity. At this time, energy storage is not needed because the amount of electricity produced by wind power is small enough that all of the electricity can be incorporated into the electrical grid. When wind comprises a sizeable share of the electricity market, some form of energy storage will have to be used, and the inclusion of this component will degrade the energy payback ratio (by increasing energy requirements) as well as increase the emissions of CO₂.

Three things must also be kept in mind when viewing the wind analysis results. One is that the energy generation data for two of the wind projects (BR-II and DePere) are projections based solely on the manufacturers' predicted capacity factor for the turbines at the given site, while the capacity factor for BR-I is based on actual data. The Kenetech wind turbines at BR-I were projected to have a capacity factor of 33%, but have managed to only operate at 24% over their first four years. Lower capacity factors than predicted for the turbines at either DePere or BR-II will lower their EPR.

Second, the turbines at each project have a different life expectancy. The Tacke 600e nacelles at the DePere project are only predicted to last 20 years, while the Zond Z-46 turbines at BR-II are predicted to last 30 years. The life expectancy shouldn't affect the effectiveness of the turbines while operating, but will impact the amount of electricity they are able to generate.

Third, the energy requirements for construction of both wind farms at Buffalo Ridge are based on data from the DePere wind project. Neither cost nor energy data was available

for the on-site construction of either BR-I or BR-II. However, since the energy from these activities was no more than 10% of the overall energy requirements for any of the wind projects, even a 20% difference in the energy requirements for either Buffalo Ridge wind project would not significantly change the results.

Other papers have reported EPR's for wind turbines ranging from four [27] to 80 [25]. The lower EPR was for a small 100 kW_e wind turbine while the higher one was for a 600 kW_e turbine performed by the Danish Wind Turbine Manufacturers Association.

4.2 CO₂ Analysis

The results of the carbon dioxide analyses as shown in Tables 10 and 11 are normalized in two ways. In Table 10, the CO₂ requirements are normalized per gigawatt of installed-capacity for the entire wind farm. The data in Table 11 is normalized per gigawatt-hour of electricity generated. For the most part, the CO₂ emissions parallel the energy requirements.

Process	Buffalo Ridge Phase I	Buffalo Ridge Phase II	DePere
Materials Production	444,337	587,341	855,292
Materials Transportation	43,613	18,877	27,513
On-site Construction & Assembly	44,220	61,749	77,186
Operation & Maintenance	215,617	118,146	98,455
Decommissioning & Dismantlement	22,110	30,874	38,593
Total	769,898	816,987	1,097,039

Process	Buffalo Ridge Phase I	Buffalo Ridge Phase II	DePere
Materials Production	8.3	6.4	15.7
Materials Transportation	0.8	0.2	0.5
On-site Construction & Assembly	0.8	0.7	1.4
Operation & Maintenance	4.0	1.3	1.8
Decommissioning & Dismantlement	0.4	0.3	0.7
Total	14.4	8.9	20.2

Figure 8 shows that the CO₂ emissions from materials production are the dominant source in the wind plants' life-cycle. Highlighted in Figure 9, materials production is responsible for the greatest share of CO₂ from BR-I (58%), BR-II (72%) and DePere (78%). Materials production is responsible for a greater share of the total CO₂ emissions than their

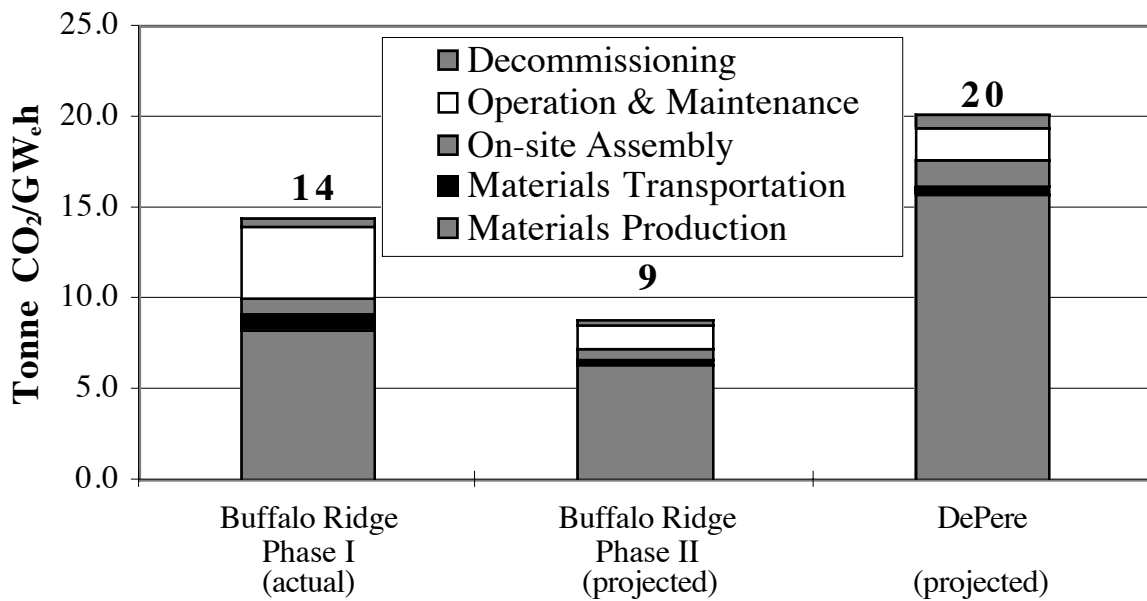

Figure 8: Lifetime CO₂ Emissions from the DePere Wind Project are Twice Those from BR-II.

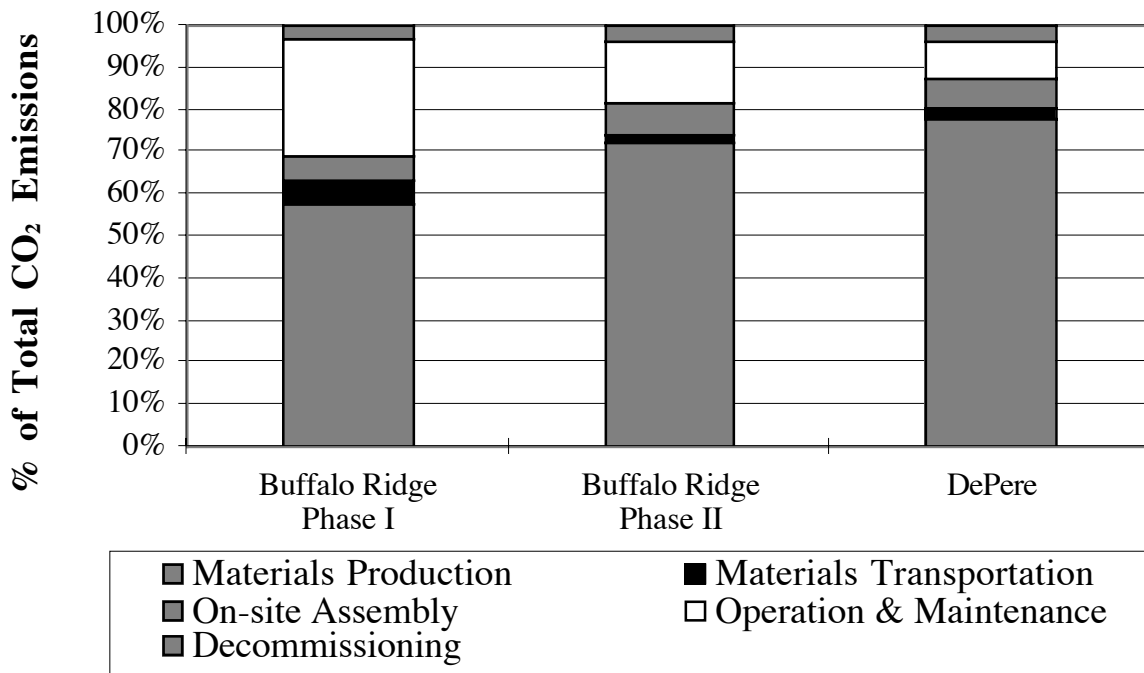

Figure 9: Wind Farm CO₂ Emissions are Dominated by Materials Procurement.

share of the total energy requirements. The share of CO₂ emissions from the other processes largely parallels those in the energy analysis. As shown in Figure 9, the normalized CO₂ emissions from the DePere wind project materials' production are greater than the overall totals of either Buffalo Ridge wind project. The reason for this is partly due to the greater mass of materials for the DePere nacelles and towers as well as the shorter lifetime of the nacelles. The result of both is less electricity is generated over its lifetime.

The reason for materials production's greater share of the CO₂ emissions than the energy requirements lies in the fuel mixture. While the energy requirements from construction, operation and maintenance, materials transportation and decommissioning processes are assumed to come from diesel fuel, the energy requirements from materials production come from a mixture of fuels. This mixture includes coal (for ore smelting) and

electricity (55% of which is from coal in the United States). The percentage of CO₂ in these fuels is higher per unit of energy than that of diesel fuel.

The amount of CO₂ emitted per GWh from decommissioning, on-site assembly and materials transportation are small; each comprising less than 10% of the total emissions of the respective wind projects. The normalized emissions from operations and maintenance follow the same trend of the energy requirements, which was discussed previously.

The total CO₂ emission per GWh for the DePere project is twice as much as the emissions from BR-II. As stated in the energy analysis, the difference here is largely related to the predicted lifetime of the nacelles, and the differences in capacity factors. The BR-II nacelles are projected to produce significantly more electricity per turbine than the nacelles at DePere and BR-I. The difference in projected electricity generation is the biggest advantage of the BR-I (Zond) nacelles over the others. The DePere turbines are also penalized in these results by a lesser wind resource, which requires the towers to be taller, which makes them heavier in order to tap into more consistent winds. The greater amount of materials requires more energy, which in turn produces more CO₂.

For comparison, as seen in Figure 10, the amount of CO₂ from BR-I compares favorably with emissions from nuclear fission and fusion. While conventional coal plants produce significantly greater amounts of CO₂ (50-100 times more), wind competes favorably with these other low-carbon sources of electricity.

The wind power plants in this analysis emit between nine and 20 tonnes of CO₂ per GW_eh. These results compare favorably with results from other studies, which are in

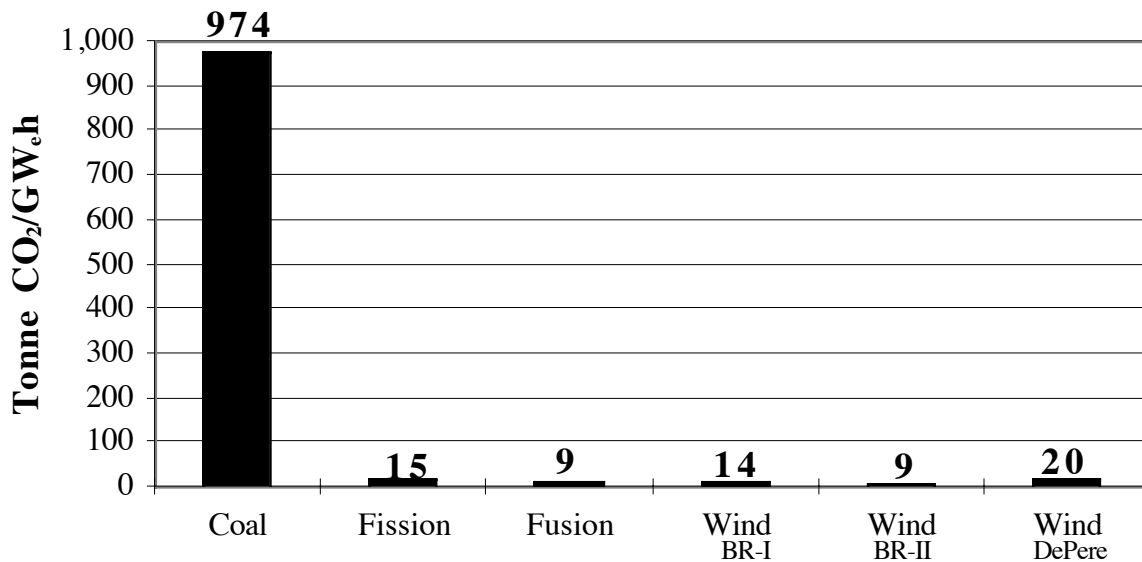

Figure 10: The CO₂ Emission Rates of Electrical Power Plants are Dominated by Coal [35].

similar units; 7.4 from San Martin [31], 18 from Friedrich and Marheineke [29], and 73 from Uchiyama and Yamamoto [27].

Though CO₂ emissions from wind are very small compared to coal, they are still responsible for some emissions. The amount of electricity produced per turbine, which is a factor of the number of years the nacelle operates and the capacity factor (which is a factor of both wind and nacelle availability), has the greatest impact on the CO₂ emission factor of wind-generated electricity. The amount of CO₂ emitted per GWh of electricity generated has a range of two, but it is still 50-100 times less than coal-generated electricity.

5. Conclusions

There are five main conclusions to this study:

- The energy payback ratio for wind-powered electricity ranges from a low of 17 for the DePere Wind Project, followed by 23 at the Northern States Power Phase-I facility at Buffalo Ridge and 39 at BR-II.
- In terms of the energy payback ratio, wind compares favorably to baseload electricity mainstays coal (11) and nuclear fission (16).
- Carbon dioxide emissions from wind-generated electricity range from nine tonnes per GWh of electricity produced at BR-II to 14 at BR-I to 20 at the DePere wind project. Though these emissions are low compared to the 974 tonnes of CO₂/GWh for a conventional coal plant, they are not zero.
- The low capacity factor is the main reason that wind power plants are not significantly better than baseload technologies with respect to EPR and CO₂ emission factors.
- The greatest differences between the energy payback and CO₂ emissions from individual wind turbines are the length of time and the capacity factor of which they are producing electricity.

Despite popular rhetoric in both the nuclear and renewable communities, these technologies *are* responsible for some CO₂-emissions. Though on the surface and in comparison to the high emissions of coal power plants, the distinction between “no CO₂ emissions” and “low CO₂ emissions” may seem trivial. However, it is an important

distinction to make, since exaggerated claims such as “wind power plants are carbon-free” are used as rhetoric by proponents of the technology in the global warming debate to draw attention to only one positive feature of that technology. Proponents of nuclear power make similar statements. Though it should be enough that wind and nuclear technologies are responsible for 1% to 2% as much CO₂ as conventional coal power plants, the exaggerated claims only tend to polarize their opponents. Misinformation raises the question, “If this claim is exaggerated how much of their other claims are also?”

The amount of electricity produced per turbine, which is a factor of the number of years the nacelle operates and the capacity factor (which is composed of both wind and nacelle availability), has the greatest impact on the CO₂ emission factor of wind-generated electricity. The amount of CO₂ emitted per GWh of electricity generated has a range of two, which is still 50-100 times less than coal-generated electricity. Fission and fusion power plants are responsible for similar amounts of CO₂ per unit of electrical energy produced as wind.

The main reason wind power plants are not significantly better than baseload power plants in terms of both energy payback and CO₂ emissions is due to their low-capacity factor. Despite a capacity factor of 24% for wind that is one-third that of coal and nuclear technologies (75%), the EPR of wind power plants is better than coal and fission, and comparable to fusion. The CO₂ emission factor for wind is also in the same range as fission and fusion. A higher capacity factor would mean more generated electricity, but would not require significantly more energy input.

It must be noted that for wind to compete with baseload technologies, an analysis such as this would need to include the energy requirements and CO₂ emissions from energy storage units for the wind power plant. Since wind-generated electric power can never fully compete with baseload technologies until it can supply electricity at all times, a comparison of baseload technologies to wind without energy storage favors wind. It is likely that the inclusion of energy storage units would decrease the EPR of wind due to both increased energy requirements and decreased overall efficiency. At the same time, the CO₂ emissions per unit of electricity produced for wind would increase. Currently, energy storage is not used with wind farms.

Acronyms and Abbreviations

BR-I	=	Buffalo Ridge Phase-I, 25 MW wind project owned and operated by LG&E, Inc. The energy is purchased by Northern States Power.
BR-II	=	Buffalo Ridge Phase-II, 107 MW wind project owned and operated by Enron Wind Corp. The energy is purchased by Northern States Power.
DePere	=	DePere Wind Project or DePere Low Wind Speed Turbine Research Project
DOE	=	Department of Energy (U.S.)
EIA	=	Energy Information Administration, part of DOE
EPRI	=	Electric Power Research Institute
GWh	=	Gigawatt-hours = 10^6 kWh = 10^3 MWh
kWh	=	Kilowatt hour, one thousand watts of power over one hour
LG&E	=	LG&E, Inc., Costa Mesa, CA, formerly known as Louisville Gas & Electric
MWh	=	Megawatt hour = 10^3 kWh
Nacelle	=	Wind turbine
NSP	=	Northern States Power utility (Minnesota)
Tonne	=	Metric tonne or 1000 kilograms
TVP	=	Wind Turbine Verification Program, a program co-sponsored by DOE and EPRI
UN FCCC	=	United Nations Framework Convention on Climate Change held in Kyoto, Japan in December 1997
WPSC	=	Wisconsin Public Service Corporation Utility, Green Bay, WI

Acknowledgements

The authors would like to thank those who helped make this analysis possible. Mr. Bob Sykes of LG&E, Inc. provided technical specifications, background data and electrical generation data for the Buffalo Ridge Phase-I wind facility. Mr. Jayme VanCampenhout and Mr. Ray Janssen of Wisconsin Public Service Corp. and Mr. Andre Rast and Mr. Helge Wittholz of Huron Wind Corporation (now PH Components) all provided technical and background data for the Tacke 600e wind turbine and DePere Low-Speed Wind Project. Mr. Andy Zalay of Zond Energy Systems provided technical specifications and other data for the Zond Z-46 wind turbine. The Energy Center of Wisconsin provided financial support for this project.

References

- [1] Flavin, C., “Last Tango in Buenos Aires”, *World Watch*, **11**(6), (1998), pp. 10-18.
- [2] Annapolis Center, “Global Climate Change: Policy Making in the Context of Scientific and Economic Uncertainty”, The Annapolis Center, Annapolis, Maryland (Oct. 1997).
- [3] “Kyoto Protocol to the United Nations Framework Convention on Climate Change”, United Nations (11 December 1997).
- [4] Convention on Climate Change, “Ratification Status of Kyoto Protocol,” 12 December 1998, WWW, www.cop4.org.
- [5] Energy Information Administration, “Impacts of the Kyoto Protocol on U.S. Energy Markets and Economic Activity”, EIA, SR/OIAF/98-03 (Oct. 1998).
- [6] Energy Information Administration, “Renewable Energy Annual 1997 Volume I”, EIA, DOE/EIA-0603(97/1) (February 1998).
- [7] Flavin, C., “Slowing Global Warming: A Worldwide Strategy”, *World Watch*, Paper 91 (Oct. 1989).
- [8] Reopelle, K., “Wind Turbines Already Supply Clean Power”, in *Wisconsin State Journal*, Madison, WI, 26 July, 1998.
- [9] Brower, M.C., M.W. Tennis, E.W. Denzler, and M.M. Kaplan, “Powering the Midwest: Renewable Electricity for the Economy and the Environment”, Union of Concerned Scientists (1993).
- [10] Elliot, D.L. and D.L. Schwartz, “Wind Energy Potential in the United States”, Pacific Northwest Laboratory, PNL-SA-23109 (September 1993).
- [11] Elliot, D.L., et al., “Wind Energy Resource Atlas of the United States”, Solar Energy Research Institute, DOE/CH 10093-4 (1987).
- [12] McGowin, C., et al., “DOE-EPRI Distributed Wind Turbine Verification Program (TVP III)”, presented at Windpower 1997, Austin, Texas, 15-18 June 1997.
- [13] Energy Information Administration, “Annual Energy Review 1996”, EIA, DOE/EIA-0384(96) (July 1997).

- [14] Energy Information Administration, "Renewable Energy Annual 1996", EIA, DOE/EIA-0603(96) (April 1997).
- [15] Sykes, R., Representative of LG&E Power, Inc., Personal Communication, 25 November 1997.
- [16] Zond Energy Systems, Inc., "The Z-46 Variable Speed Wind Turbine Generator", Zond Energy Systems, Inc., Technical Description and Data Report, #00042 Rev. A (5 October 1997).
- [17] "Low Wind Speed Turbine Project," September 5 1998, Web-page, www.wisconsinwindproject.com.
- [18] Lamarre, L., "Renewables in a Competitive World", *EPRI Journal*, **20**(6), (1995), pp. 16-25.
- [19] Northern States Power, "NSP Wind Timeline," 30 November 1998, Web, <http://www.nspco.com/renewables/windtime.htm>.
- [20] Perry, A.M., et al., "Net Energy Analysis of Five Energy Systems", Oak Ridge Associated Universities, ORAU/EIA(R)-77-12 (September 1977).
- [21] Devine, W.D., Jr., "An Energy Analysis of a Wind Energy Conversion System for Fuel Displacement", Oak Ridge Associated Universities, ORAU/IEA(M)-77-2 (February 1977).
- [22] Jensch, W., "Vergleich von Energieversorgungssystemen unterschiedlicher Zentralisierung (Comparison of Energy Supply Systems with Different Degrees of Centralization)", *IfE Schriftenreihe, München*, (1988), pp. 22.
- [23] Fritsche, U., L. Rausch, and K.-H. Simon, "Umweltwirkungsanalyse von Energiesystemen: Gesamt-Emissions-Modell Integrierter Systeme (GEMIS) ("Environmental Impact Analysis of Energy Systems: Total Emission Model for Integrated Systems (GEMIS)"), Öko-Institut, Darmstadt (1989).
- [24] Hagedorn, G., "Kumulierter Energieverbrauch und Erntefaktoren von Windkraftanlagen ("Cumulative Energy Use and Harvest Factors of Wind Turbines")", *Heft 1/2*, (1992), pp. 42.
- [25] Danish Wind Turbine Manufacturers Association, "The Energy Balance of Modern Wind Turbines", *Wind Power Note*, **16** (1997).
- [26] Grum-Schwensen, E., "The Real Cost of Wind Turbine Construction", *WindStats Newsletter*, **3**(2), (1990), pp. 1.
- [27] Uchiyama, Y. and H. Yamamoto, "Energy Analysis of Power Generation Plants", CRIEPI - Economic Research Center, Y90015 (1991).

- [28] Uchiyama, Y., “Life Cycle Analysis of Electricity Generation and Supply Systems”, presented at Symposium on Electricity, Health and the Environment: Comparative Assessment in Support of Decision Making, Vienna, Austria, 16-19 October 1995, pp. 279-291.
- [29] Friedrich, R. and T. Marheineke, “Life Cycle Analysis of Electricity Systems: Methods and Results”, presented at IAEA Advisory Group Meeting/Workshop, Beijing, China, 4-7 October 1994, pp. 67-75.
- [30] Lewin, B., “CO₂-Emission von Kraftwerken unter Berücksichtigung der vor- und nachgelagerten Energieketten”, *VDI Berichte*, (1093), (1993).
- [31] San Martin, R.L., “Environmental Emissions from Energy Technology Systems: The Total Fuel Cycle”, USDOE (Spring 1989).
- [32] Uchiyama, Y., “Validity of FENCH-GHG Study: Methodologies and Databases”, presented at IAEA Advisory Group Meeting/Workshop, Beijing, China, 4-7 October 1994, pp. 85-94.
- [33] Van De Vate, J.F., “Full Energy Chain Analysis of Greenhouse Gas Emissions from Different Energy Sources”, presented at IAEA Advisory Group Meeting/Workshop, Beijing, China, 4-7 October 1994, pp. 11-17.
- [34] Yasukawa, S., Y. Tadokoro, and T. Kajiyama, “Life Cycle CO₂ Emissions from Nuclear Power Reactor and Fuel Cycle System”, presented at Expert Workshop on Life-cycle Analysis of Energy Systems, Methods and Experience, Paris, France, 21-22 May 1992.
- [35] White, S.W., “Net Energy Payback and CO₂ Emissions from ³He Fusion and Wind Electrical Power Plants”, Ph.D. Thesis, University of Wisconsin - Madison (1998).
- [36] White, S.W. and G.L. Kulcinski, “Energy Payback Ratios and CO₂ Emissions Associated with the UWMAK-I and ARIES-RS DT-Fusion Power Plants”, *Fusion Technology* (1998).
- [37] Newman, J., “Two Wind Turbines Are Up and Running”, in *Wisconsin State Journal*, Madison: 22 February, 1998, pp. 3E.
- [38] Crowther, M.A. and P.D. Moskowitz, “A Reference Material System for Estimating Health and Environmental Risks of Selected Material Cycles and Energy Systems”, Brookhaven National Laboratory, BNL 51563 (July 1981).
- [39] “Energy Use Patterns in Metallurgical and Nonmetallic Mineral Processing (Phase 4 - Energy Data and Flowsheets, High-Priority Commodities)”, Bureau of Mines, PB-245 759 (27 June 1975).

- [40] Vant-Hull, L.L., "Solar Thermal Central Receivers: Current Status and Future Promise", *Solar Today* (1992), pp. 13-16.
- [41] Bünde, R., "The Potential Net Energy Gain from DT Fusion Power Plants", *Nuclear Engineering and Design/Fusion*, **3**(1985), pp. 1-36.
- [42] Sykes, R., Representative of LG&E Power, Inc., Personal Communication, 12 March 1998.
- [43] Zalay, A., Zond Energy Systems, Personal Communication, 13 January 1998.
- [44] Rast, A., Huron Windpower, Personal Communication, 24 February 1998.
- [45] Sykes, R., Representative of LG&E Power, Inc., Personal Communication, 3 February 1998.
- [46] Zalay, A., Enron Wind Corporation, Personal Communication, 18 February 1998.
- [47] Rast, A., Huron Windpower, Personal Communication, 3 February 1998.
- [48] Mapquest™, "Roadmaps," 3 February 1998, World-Wide Web, <http://roadmaps.lycos.com/roadmap.html>.
- [49] Wittholz, H., PH Components, Personal Communication, 17 September 1998.
- [50] Bureau of Labor Statistics, "Consumer Price Index - All Urban Consumers," 13 March 1998, Wide-World Web, <http://146.142.4.24/cgi-bin/surveymost?cu>.
- [51] Spreng, D.T., *Net Energy Analysis and the Energy Requirements of Energy Systems*. New York: Praeger (1988).
- [52] Sykes, R., Representative of LG&E Power, Inc., Personal Communication, 25 September 1998.
- [53] Enron Wind Corp., "Zond Energy Systems Technical Drawings and Data," 1 December 1998, Web-site, <http://www.wind.enron.com/zond/drawing.html>.

Appendix A – Energy and Emission Factors

Table A.1 lists the standard U.S. electrical distribution as used in this report. The thermal conversion efficiencies in the fourth column are for individual technologies. The net conversion efficiency, in the final column, takes into account the energy used in other areas of the power plant (construction, operations, fuel acquisition, etc.). To determine the net conversion efficiency, the following equation is used:

$$\eta_n = \eta_{th} \left(1 - \frac{1}{EPR} \right)$$

where η_n = net conversion efficiency,

η_{th} = thermal conversion efficiency,

and EPR = initial Energy Payback Ratio.

The initial energy payback ratios are listed in Table A.2 and are based on previous work for coal and fission, and on other reports. Table A.3 shows the electrical efficiencies used in this report.

Table A.1: Standard U.S. and Aluminum Smelter Electrical Distribution and Thermal and Net Conversion Efficiencies of Power Plants				
Power Plant Technology	Standard U.S. Distribution¹	Aluminum Smelter Mix²	Thermal Conversion Efficiency³	Net Conversion Efficiency⁴
Coal	56.5%	41.9%	35%	32%
Hydro	10.7%	39.9%	83%	78%
Nuclear -PWR	21.9%	10.3%	33%	31%
Petroleum	2.2%	1.6%	35%	32%
Natural Gas	8.7%	6.5%	37%	36%

¹ From Monthly Energy Review, March 1997[1] based on 1996 U.S. electrical energy mix.

² From Ref. [2].

³ From the DOE's Energy Technology Characterization Handbook[3].

⁴ For Standard U.S. Distribution, uses the equation $\eta_n = \eta_{th} (1 - 1/EPB)$, where EPB = initial Energy Payback Ratio (see Table A.2).

Table A.4 lists the energy requirements of transportation via rail, ship and truck. These factors were used in determining the energy requirements to transport coal as well as wind-plant components.

Table A.2: Initial Energy Payback Ratios	
Power Plant Technology	Initial Energy Payback Ratio
Coal ⁵	11
Hydro ⁶	16.9
Nuclear – PWR ⁵	16
Petroleum ⁶	13.6
Natural Gas ⁷	25

⁵ From White, 1998, ref. [4].

⁶ From Uchiyama, ref. [5].

⁷ Estimated. No other references could be found.

Table A.3: Electricity Efficiency Average in U.S.	
Electrical Mix	Efficiency
Standard	36.9%
Aluminum	53.4%

Table A.4: Energy Requirements for Transportation	
Transportation Method	GJ/net-tonne mile
Rail ⁸	0.000408
Ship ⁹	0.000291
Truck ⁹	0.002790

⁸ From Ref. [3].

⁹ Values used in Refs. [6, 7].

Table A.5 lists the CO₂ emission factors for all fuels used in this report, thermal and electrical. Much of this data was only used in determining the CO₂ emissions from materials production. Table A.6 lists the weighted CO₂ emissions from both the standard U.S. electrical mix and the aluminum electrical mix. The aluminum electrical mix is the mix of electricity that is used in aluminum production. Table A.7 lists the heating values of various fossil fuels and electricity.

Fuel	Fuels¹⁰ kg CO₂/GJ_{th}	Electricity¹¹ kg CO₂/MW_eh
Coal	92.77	975
Hydro	NAppl. ¹²	3.1
Nuclear (PWR)	NAppl.	17
Petroleum	69.30	726
Natural Gas	50.53	484
Oil	73.33	NAppl.
Petroleum Coke	96.81	NAppl.
Metallurgical Coke	89.06	NAppl.
Diesel	72.23	NAppl.
Residual Fuel oil	78.00	NAppl.
Propane	59.77	NAppl.
Butane	61.60	NAppl.
Kerosene	71.20	NAppl.
LPG	59.65	NAppl.

¹⁰ All emission factors are from Mintzer, Ref. [8], except natural gas[9], metallurgical coke[1], and LPG[10].

¹¹ CO₂ emission factors for electricity from hydroelectric, petroleum and natural gas are from San Martin[11]; emission factors for coal and fission are from White[4].

¹² Not Applicable.

Technology	Standard U.S. Electrical Mix Weighted Tonnes CO₂/MW_eh	Aluminum Smelter Mix Weighted Tonnes CO₂/MW_eh
Conventional Coal Plant	0.5509	0.4082
Petroleum	0.016	0.0118
Natural Gas	0.0421	0.0312
Hydroelectric	0.0003	0.0012
Nuclear Fission (BWR)	0.0037	0.0017
	0.613	0.4541

Fuel	Units	BTU/Unit	MJ/Unit
Electricity (Standard) ¹³	MW _e h	10,500,000	11,078
Petroleum Coke ¹³	Tonne	30,000,000	31,650
Metallurgical Coke ¹⁴	Tonne	24,800,000	26,164
Coal ¹⁴	Tonne	22,195,000	23,416
Diesel Gas ¹³	Gal.	139,000	147
Distillate Fuel Oil ¹³	Gal.	139,000	147
Residual Fuel Oil and Other HC Fuels ¹³	Gal.	150,000	158
Petroleum/gasoline ¹³	Gal.	125,000	132
Natural Gas ¹³	Ft ³	1,000	1
Propane ¹³	Gal.	95,000	100
Kerosene ¹³	Gal.	135,000	142
LPG ¹³	Gal.	94,000	99
Propane ¹⁵	Ft ³	830	0.9
Ethane ¹⁵	Ft ³	670	0.7

¹³ From Ref. [12].

¹⁴ From Ref. [13].

¹⁵ Propane is based on 83% of natural gas heating value and ethane is based on 67% of natural gas heating value, as calculated in Table A1 in Ref. [14].

References – Appendix A

- [1] Energy Information Administration, “Monthly Energy Review”, EIA, DOE/EIA-0035(97/3) (March 1997).
- [2] “Energy Use Patterns in Metallurgical and Nonmetallic Mineral Processing (Phase 4 - Energy Data and Flowsheets, High-Priority Commodities)”, Bureau of Mines, PB-245 759 (27 June 1975).
- [3] “Energy Technology Characterizations Handbook”, U.S. DOE, DOE/EP-0093 (March 1983).
- [4] White, S.W. and G.L. Kulcinski, “‘Birth to Death’ Analysis of the Energy Payback Ratio and CO₂ Gas Emission Rates from Coal, Fission, Wind, and DT Fusion Power Plants”, *Fusion Engineering (To Be Published)*, (1999).
- [5] Uchiyama, Y., “Life Cycle Analysis of Electricity Generation and Supply Systems”, presented at Symposium on Electricity, Health and the Environment: Comparative Assessment in Support of Decision Making, Vienna, Austria, 16-19 October 1995, pp. 279-291.
- [6] Penner, P. and J.K. Spek, “STOCKPILE OPTIMIZATION: Energy and Versatility Considerations for Strategic and Critical Materials”, University of Illinois at Urbana-Champaign, CAC Document No. 217 (May 1976).
- [7] “Energy Use Patterns in Metallurgical and Nonmetallic Mineral Processing (Phase 7 - Summary of the Results of Phases 4, 5, and 6)”, Battelle Columbus Laboratories, Final Report, PB 261 151 (21 September 1976).
- [8] Mintzer, I., “Weathering the Storms in a Warming World”, *Public Power*, **46**(6), (1988), pp. 15-21.
- [9] Marland, G., “Carbon Dioxide Emission Rates for Conventional and Synthetic Fuels”, *Energy*, **8**(12), (1983), pp. 981-992.
- [10] Energy Information Administration, “Emissions of Greenhouse Gases in the United States 1987-1992”, Energy Information Administration, DOE/EIA-0573 (October 1994).
- [11] San Martin, R.L., “Environmental Emissions from Energy Technology Systems: The Total Fuel Cycle”, USDOE (Spring 1989).
- [12] “Energy Use Patterns in Metallurgical and Nonmetallic Mineral Processing (Phase 6 - Energy Data and Flowsheets, Low-Priority Commodities)”, Battelle Columbus Laboratories, Final Report, PB 261 150 (21 July 1976).
- [13] Energy Information Administration, “Monthly Energy Review”, EIA (September 1994).
- [14] Energy Information Administration, “Annual Energy Review 1994”, EIA, DOE/EIA-0384(94) (July 1995).

Appendix B - Buffalo Ridge Phase-I Wind Farm[1]

The wind power plant analyzed for this report is a 25 MW_e facility that is in operation in Southwestern Minnesota along the Buffalo Ridge near Lake Benton, MN. The wind farm provides electric power for the Northern States Power utility of Minnesota and is operated by LG&E, Inc. in Costa Mesa, California. This wind farm was the first of at least three phases of wind turbines that will eventually be built on the Buffalo Ridge. For the purpose of this report, it is referred to as the Buffalo Ridge Phase-I (BR-I) wind farm.

Table B.1 lists the relevant parameters of the wind farm. While the entire power plant is designed to produce a maximum of 25 MW_e, individually, each of the 73 wind turbines has a rated power of 342.5 kW_e. It is expected that each nacelle (wind turbine) will last for 25 years. The expected capacity factor for the turbines, according to the manufacturer's quote, was 33%. So far, with four years of operation, the BR-I wind farm has only maintained a capacity factor of 24%.

Table B.1: Parameters for Buffalo Ridge Phase-I Wind Farm	
Parameters¹	
Turbine Manufacturer & Model	Kenetech
Turbine Model	KVS-33
Rated Power per Turbine (kW _e)	342.5
Gross Rated Power per Turbine (kW _e)	410.0
Number of Turbines per Power Plant	73
Rated Power Plant Output (MW _e)	25
Expected Life of Turbine (years)	25
Capacity Factor (Predicted)	33%
Capacity Factor (Actual) ²	24%
Tower Height (feet)	120
Rotor Diameter (feet)	108

¹ From Ref. [2].

² See Table B.7.

Table B.2 lists the mass of both individual wind turbines and the wind farm as a whole. All of this data was collected from private conversations with a representative of LG&E, Inc.[2]. The energy requirements and emissions from materials were calculated in the same manner as described in Section 3. Table B.2 also lists the type of material used for each component.

The type and length of wire and cable used in each turbine was also obtained from LG&E[2]. The total mass was calculated by multiplying the length of wire by the weight per unit length of each type of wire, as obtained in Ref. [3]. The results are in Table B.3.

In the analysis, the energy requirements for wind farm construction include both transporting the components to the construction site and the actual onsite construction. The distances and related data for transporting the wind turbine components from the manufacturing site to Lake Benton, MN are listed in Table B.4. The manufacture site data for each component was obtained from LG&E[4]. The distances between these sites were calculated using the Mapquest™ map-generating program[5], which can determine the distances between two

Table B.2: Buffalo Ridge Phase-I Wind Project				
Component	Material	Mass/ Turbine (lbs.)³	Mass/ Turbine (tonnes)	Total Mass for Wind Farm - 73 turbines (tonnes)
Nacelle	Cast Iron	20,500	5.9	430
Rotor/Blades ⁴	Fiberglass	7,500	6.8	497
Towers	Steel	43,360	19.7	1,435
Foundation	Concrete	84.78 yds ³	136.1	9,937
Electrical Wire	Copper	-	0.073	5
Control Cabinet	Steel	1,000	0.5	33

³ Ref. [2].

⁴ Totals include two sets of blades per turbine. The fiberglass blades are designed to last for the lifetime of the nacelle, but due to a design flaw in the case of BR-I, it was predicted that all blades will have to be replaced once over the lifetime of the plant[2].

Table B.3: Type, Length and Mass of Wire & Cable					
Function	Type⁵	Length⁶	Number	Weight per 1000 ft., (lb.)⁷	Total Mass, kg
Power (turbine to inverter)	3-0 awg	130 ft	6	163	57.67
Grounding Cable	1-0 awg	107 ft	1	258	12.52
Auxiliary Power Cable	10 awg	130 ft	1	31.4	1.85
Tachometer cable	20 awg	100 ft	7	3.09	0.98
Total Mass of Wire/Turbine (kg)					73.0

Table B.4: Data for the Transportation of Wind Turbine Components					
Origin/Destination⁸	Method	Mass	Miles	Energy (GJ)	
<i>Nacelle - (Turbine w/o blades)</i>					
Milwaukee, WI to Livermore, CA	Truck	430	2,190	2,630	
Livermore, CA to Lake Benton, MN	Truck	430	1,920	2,306	
Total					4,935
<i>Rotors/Blades</i>					
Kent, WA to Lake Benton	Truck	497	1,605	2,224	
<i>Towers</i>					
El Paso, TX to Lake Benton	Truck	1,435	1,480	5,928	
<i>Concrete</i>					
Sioux Falls, SD to Lake Benton	Truck	9,937	66	1,830	
<i>Control Cabinet</i>					
Livermore, CA to Lake Benton	Truck	33	1,920	177	
Total Transportation Energy					15,094

⁵ Ref. [2].

⁶ Ref. [2].

⁷ Ref. [3].

⁸ Ref. [4].

towns or addresses. The energy requirements per transportation mode are listed in Appendix A. To calculate the CO₂ emissions from component transportation, it was assumed that all energy requirements were from diesel fuel. The diesel fuel emission factor was then multiplied by the amount of fuel that would be needed to provide this energy. Heating values for diesel and other fuels are also listed in Appendix A.

Data on the energy requirements to construct the BR-I wind farm was not available. The data used for this analysis was scaled from data to construct a two-turbine wind farm in DePere, WI. The data for this project is located in Table B.5. The energy requirements for the BR-I turbine/tower assemblies were scaled from the DePere data by a factor of 12 based on the ratio:

$$\left(\frac{\# \text{ of turbines BR - I}}{\# \text{ of turbines DePere}} \right) * \left(\frac{\text{Mass of 1 BR - I turbine/tower assembly}}{\text{Mass of 1 DePere turbine/tower assembly}} \right) = \frac{73}{2} * \frac{169}{517} = 11.9$$

The turbines at the DePere site are both significantly larger in mass than those at BR-I as well as having a higher rating (600 kW_e) than those at BR-I. In calculating the CO₂ emissions for construction, it was assumed that all energy came from diesel fuel.

The energy requirements for operation and maintenance were calculated using the I/O method. Total revenue for LG&E[6] is based on a fixed cost of \$7500 per year per turbine and a variable cost of 0.75¢/kWh generated. Of the total revenue generated, 55.6% goes towards O&M. Table B.5 lists the yearly revenue from BR-I from 1995 through 2019, a 25-year period. All costs were translated into 1995 dollars, using the Consumer Price Index[7]. In Table B.6 is a worksheet used to calculate the energy requirements of O&M for BR-I. The lifetime energy requirements are shown at the bottom. In calculating the CO₂ emissions, it was assumed that all O&M energy requirements were from diesel fuel.

Table B.5: Projected Yearly Revenue for Buffalo Ridge Phase-I

Year	MWh	Fixed Costs	Variable	CPI #	1995\$/year
		1995\$/year /turbine	Costs 1995\$/ kWh		
1995	54,765	7500	\$0.0075	152.4	\$958,240
1996	50,419	7500	\$0.0075	156.9	\$899,095
1997	53,522	7500	\$0.0075	160.5	\$901,023
1998	53,522	7500	\$0.0075	168.5	\$858,117
1999	53,522	7500	\$0.0075	177.0	\$817,254
2000	53,522	7500	\$0.0075	185.8	\$778,337
2001	53,522	7500	\$0.0075	195.1	\$741,274
2002	53,522	7500	\$0.0075	204.8	\$705,975
2003	53,522	7500	\$0.0075	215.1	\$672,357
2004	53,522	7500	\$0.0075	225.8	\$640,340
2005	53,522	7500	\$0.0075	237.1	\$609,848
2006	53,522	7500	\$0.0075	249.0	\$580,807
2007	53,522	7500	\$0.0075	261.4	\$553,150
2008	53,522	7500	\$0.0075	274.5	\$526,809
2009	53,522	7500	\$0.0075	288.2	\$501,723
2010	53,522	7500	\$0.0075	302.6	\$477,832
2011	53,522	7500	\$0.0075	317.8	\$455,078
2012	53,522	7500	\$0.0075	333.7	\$433,407
2013	53,522	7500	\$0.0075	350.4	\$412,769
2014	53,522	7500	\$0.0075	367.9	\$393,113
2015	53,522	7500	\$0.0075	386.3	\$374,394
2016	53,522	7500	\$0.0075	405.6	\$356,565
2017	53,522	7500	\$0.0075	425.9	\$339,586
2018	53,522	7500	\$0.0075	447.1	\$323,415
2019	53,522	7500	\$0.0075	469.5	\$308,015
					\$14,618,524

There was no available data on the energy requirements to decommission a wind plant at the time of this study. For this reason, an assumption was made that it would take approximately the same amount of energy to completely dismantle the turbines as it would to assemble them. At the same time, it is assumed that while the nacelles with all their moving parts will only last 25 years, the towers that support the nacelles will last longer than that. For this analysis, it is assumed that a tower will last for the life of two wind turbines. Therefore, the total energy required to dismantle one turbine will be half the energy required to construct it, since the energy required for dismantlement can be amortized for two turbines. It is also assumed that the fuel used to dismantle the turbines will be diesel, the emission factor of which was used to calculate the CO₂ emissions.

Table B.8 is the actual electricity generation data from Buffalo Ridge Phase-I from March 1994 through July 1998. To calculate the average amount of electricity produced per year at the 25 MW_e wind farm, the average over a four-year period was taken. The four-year

Table B.6: Operation & Maintenance Energy Requirements Worksheet		
Total Revenue, 1995-2019 (1995\$)	\$14,618,524	
Cost to repair one set of blades ⁹ (95\$)		\$16,000
Number of sets to replace ⁹		x 7
Total Cost to Repair blades (95\$)	-\$112,000	
Adjusted Revenue, less cost of blade repair (95\$)	\$14,506,524	
Inflation Adjustment (1977/1995:60.6/152.4)		x 0.3976
Adjusted Cost of O&M (77\$)	\$5,768,342	
Share of Revenue towards O&M (%)		x 55.6%
Share of Revenue toward O&M (95\$)	\$3,207,200	
I/O Auto Repair Sector energy intensity (GJ/77\$) ¹⁰		x 0.0233
Lifetime Energy Requirements of O&M (GJ)		74,625

⁹ Ref. [8]. Full blade replacement was not anticipated in the original O&M cost expenditures, but it was anticipated that 10% of the blades could fail.

¹⁰ From I/O Table in Ref. [9].

period extends from June 1994 through May 1998. The capacity factor is calculated by dividing the yearly average of electricity (53.5 GW_eh) by the amount of electricity that would be generated if the power plant produced at its rated capacity for a full year (25 MW_e*8760 hr/yr = 219 GW_eh). The actual capacity factor of BR-I is 24%.

The energy requirements for BR-I are listed in Table B.9 and the total CO₂ emissions for the power plant are listed in Table B.10.

Table B.7: Production History of Buffalo Ridge Phase-I¹¹

Month	Actual Production (kWh)	Budget Production (kWh)	Monthly Actual as a % of Budget	Cumulative Actual as a % of Budget	Actual % Production per Month	Budget % Production per Month	Design Projected Output (kWh)	Monthly Actual % of Design Projected Output	Cumulative Design Projected Output (kWh)	Cumulative Actual % of Design Projected Output	Average Avail- ability
Mar-94	1,139,000	1,162,000	98%	98%							88%
Apr-94	1,921,000	3,244,000	59%	69%							78%
May-94	3,075,000	7,028,000	44%	54%							67%
Jun-94	3,362,000	5,790,000	58%	55%							83%
Jul-94	2,228,449	4,371,000	51%	54%							86%
Aug-94	2,344,085	4,371,000	54%	54%							85%
Sep-94	4,082,009	6,047,000	68%	57%							87%
Oct-94	6,072,747	5,318,000	114%	65%							93%
Nov-94	7,418,257	6,047,000	123%	73%							97%
Dec-94	5,578,133	6,047,000	92%	75%							82%
	37,220,680	49,425,000	75%				49,245,000	76%	49,245,000	76%	85%
Jan-95	4,448,911	6,419,000	69%	75%	8%	9%	6,556,860	68%	55,801,860	75%	96%
Feb-95	4,673,482	4,993,000	94%	76%	9%	7%	5,099,780	92%	60,901,640	76%	95%
Mar-95	5,754,084	7,208,000	80%	77%	11%	10%	7,285,400	79%	68,187,040	76%	98%
Apr-95	5,541,625	7,285,000	76%	77%	10%	10%	7,285,400	76%	75,472,440	76%	92%
May-95	3,910,756	7,285,000	54%	75%	7%	10%	7,285,400	54%	82,757,840	74%	99%
Jun-95	3,845,611	5,828,000	66%	74%	7%	8%	5,828,320	66%	88,586,160	74%	97%
Jul-95	3,524,385	4,371,000	81%	74%	6%	6%	4,371,240	81%	92,957,400	74%	94%
Aug-95	2,927,136	4,371,000	67%	74%	5%	6%	4,371,240	67%	97,328,640	74%	96%
Sep-95	4,432,344	5,828,000	76%	74%	8%	8%	5,828,320	76%	103,156,960	74%	98%
Oct-95	5,637,984	5,828,000	97%	75%	10%	8%	5,828,320	97%	108,985,280	75%	97%
Nov-95	5,964,761	5,828,000	102%	77%	11%	8%	5,828,320	102%	114,813,600	77%	98%
Dec-95	4,104,244	7,288,000	56%	75%	7%	10%	7,285,400	56%	122,099,000	75%	94%
	54,765,323	72,532,000	76%		100%	100%	72,854,000	75%	122,099,000	75%	96%

¹¹ From LG&E operational data, Ref. [10, 11].

Table B.7 Continued

Month	Actual Production (kWh)	Budget Production (kWh)	Monthly Actual as a % of Budget	Cumulative Actual as a % of Budget	Actual % Production per Month	Budget % Production per Month	Design Projected Output (kWh)	Monthly Actual % of Design Projected Output	Cumulative Design Projected Output (kWh)	Cumulative Actual % of Design Projected Output	Average Avail- ability
Jan-96	4,690,750	5,533,990	85%	76%	9%	9%	6,556,860	72%	128,655,860	75%	86%
Feb-96	6,931,063	4,304,214	161%	79%	14%	7%	5,099,780	136%	133,755,640	77%	92%
Mar-96	5,561,090	6,148,878	90%	79%	11%	10%	7,285,400	76%	141,041,040	77%	96%
Apr-96	5,770,304	6,148,878	94%	80%	11%	10%	7,285,400	79%	148,326,440	77%	97%
May-96	5,473,300	6,148,878	89%	80%	11%	10%	7,285,400	75%	155,611,840	77%	96%
Jun-96	3,567,000	4,919,102	73%	80%	7%	8%	5,828,320	61%	161,440,160	77%	93%
Jul-96	1,820,199	3,689,325	49%	79%	4%	6%	4,371,240	42%	165,811,400	76%	77%
Aug-96	2,629,102	3,689,325	71%	79%	5%	6%	4,371,240	60%	170,182,640	75%	75%
Sep-96	2,594,120	4,919,102	53%	78%	5%	8%	5,828,320	45%	176,010,960	74%	73%
Oct-96	5,398,598	4,919,102	110%	79%	11%	8%	5,828,320	93%	181,839,280	75%	72%
Nov-96	1,873,602	4,919,102	38%	78%	4%	8%	5,828,320	32%	187,667,600	74%	78%
Dec-96	4,109,898	6,148,878	67%	78%	8%	10%	7,285,400	56%	194,953,000	73%	72%
	50,419,026	61,488,774	82%		100%	100%	72,854,000	69%	194,953,000	73%	84%
Jan-97	4,282,699	5,901,174	73%	77%	8%	9%	6,556,860	65%	201,509,860	73%	84%
Feb-97	4,313,402	4,589,802	94%	78%	8%	7%	5,099,780	85%	206,609,640	73%	90%
Mar-97	5,999,699	6,556,860	92%	78%	11%	10%	7,285,400	82%	213,895,040	73%	91%
Apr-97	4,049,398	6,556,860	62%	78%	7%	10%	7,285,400	56%	221,180,440	73%	96%
May-97	5,740,078	6,556,860	88%	78%	11%	10%	7,285,400	79%	228,465,840	73%	97%
Jun-97	3,644,625	5,245,488	69%	78%	7%	8%	5,828,320	63%	234,294,160	73%	100%
Jul-97	3,192,188	3,934,114	81%	78%	6%	6%	4,371,240	73%	238,665,400	73%	96%
Aug-97	1,769,900	3,934,116	45%	77%	3%	6%	4,371,240	40%	243,036,640	72%	97%
Sep-97	4,107,788	5,245,488	78%	77%	8%	8%	5,828,320	70%	248,864,960	72%	96%
Oct-97	7,775,000	5,245,488	148%	79%	14%	8%	5,828,320	133%	254,693,280	74%	96%
Nov-97	5,055,125	5,245,488	96%	79%	9%	8%	5,828,320	87%	260,521,600	74%	96%
Dec-97	4,568,875	6,556,860	70%	79%	8%	10%	7,285,400	63%	267,807,000	74%	99%
	54,498,777	65,568,598	83%		100%	100%	72,854,000	75%	267,807,000	74%	95%

Table B.8: Lifetime and Annual Energy Investments for a Wind Power Plant (Buffalo Ridge Phase I)

Process	Source	Total Energy per Installed 25 MW _e Power Plant	Total Energy per GW _e h produced
		GJ _{th} /Power Plant	GJ _{th} /GW _e h
Turbine Materials			
Blades		6,363	4.76
Nacelles		17,499	13.08
Inverter		12,385	9.26
Wiring		696	0.52
Tower		49,431	36.94
Foundations		13,694	10.23
Materials subtotal	See Table 4.3	100,067	75
Transportation	See Table B.4	15,094	11
Construction	See Table B.5	15,305	11
Construction Subtotal		30,399	22
Operation and Maintenance	See Table B.7	74,625	56
Decommissioning (g)		7,652	6
Total Required Energy per Plant		212,744	159
Total per 1000 MW_e installation		8,509,760	
Total per 30 GW_ey			41,784,359

Table B.9: Lifetime and Annual Emissions of CO₂ for a Wind-farm (Buffalo Ridge Phase I)

Process	Source	Total Emissions per Installed 25 MW _e	Total Emissions per Installed GW _e	Emissions per GW _h _e	Emissions per GW _e _y
		Tonne CO ₂ /plant	Tonne CO ₂ / GW _e	Tonne CO ₂ / GW _e _h	Tonne CO ₂ / GW _e _y
<i>Turbine Materials</i>					
Blades	Various	399	15,978	0.30	2,615
Nacelles	Various	1,179	47,151	0.88	7,717
Inverter		778	31,100	0.58	
Wiring		40	1,588	0.03	
Tower		3,547	141,891	2.65	
Foundation		5,166	206,630	3.86	33,820
Materials subtotal		11,108	444,337	8.30	72,726
Construction		1,106	44,220	0.83	7,238
Transportation		1,090	43,613	0.81	7,138
Construction subtotal		2,196	87,833	1.14	14,376
Maintenance		5,390	215,617	4.03	35,291
Decommissioning		553	22,110	0.41	3,619
Total Emissions		19,247	769,898	14	126,011

References - Appendix B

- [1] White, S.W., "Net Energy Payback and CO₂ Emissions from ³He Fusion and Wind Electrical Power Plants", Ph.D. Thesis, University of Wisconsin - Madison (1998).
- [2] Sykes, R., Representative of LG&E Power, Inc., Personal Communication, 12 March 1998.
- [3] Avallone, E.A. and T. Baumeister III, "Marks' Standard Handbook for Mechanical Engineers," 9th ed. St. Louis, MO: McGraw-Hill Book Co. (1987).
- [4] Sykes, R., Representative of LG&E Power, Inc., Personal Communication, 3 February 1998.
- [5] Mapquest™, "Roadmaps," 3 February 1998, World-Wide Web, <http://roadmaps.lycos.com/roadmap.html>.
- [6] Sykes, R., Representative of LG&E Power, Inc., Personal Communication, 13,16 March 1998.
- [7] Bureau of Labor Statistics, "Consumer Price Index - All Urban Consumers," 13 March 1998, Wide-World Web, <http://146.142.4.24/cgi-bin/surveymost?cu>.
- [8] Sykes, R., Representative of LG&E Power, Inc., Personal Communication, 25 September 1998.
- [9] Spreng, D.T., *Net Energy Analysis and the Energy Requirements of Energy Systems*. New York: Praeger (1988).
- [10] Sykes, R., Representative of LG&E Power, Inc., Personal Communication, 25 November 1997.
- [11] Sykes, R., Representative of LG&E Power, Inc., Personal Communication, 25 September 1998.

Appendix C - Buffalo Ridge Phase II

Most original data for Phase II at Buffalo Ridge was not available. The turbines at BR-II are Zond Z-46 wind turbine generators, which are part of Zond's Z-750 series as seen in Figure C.1.

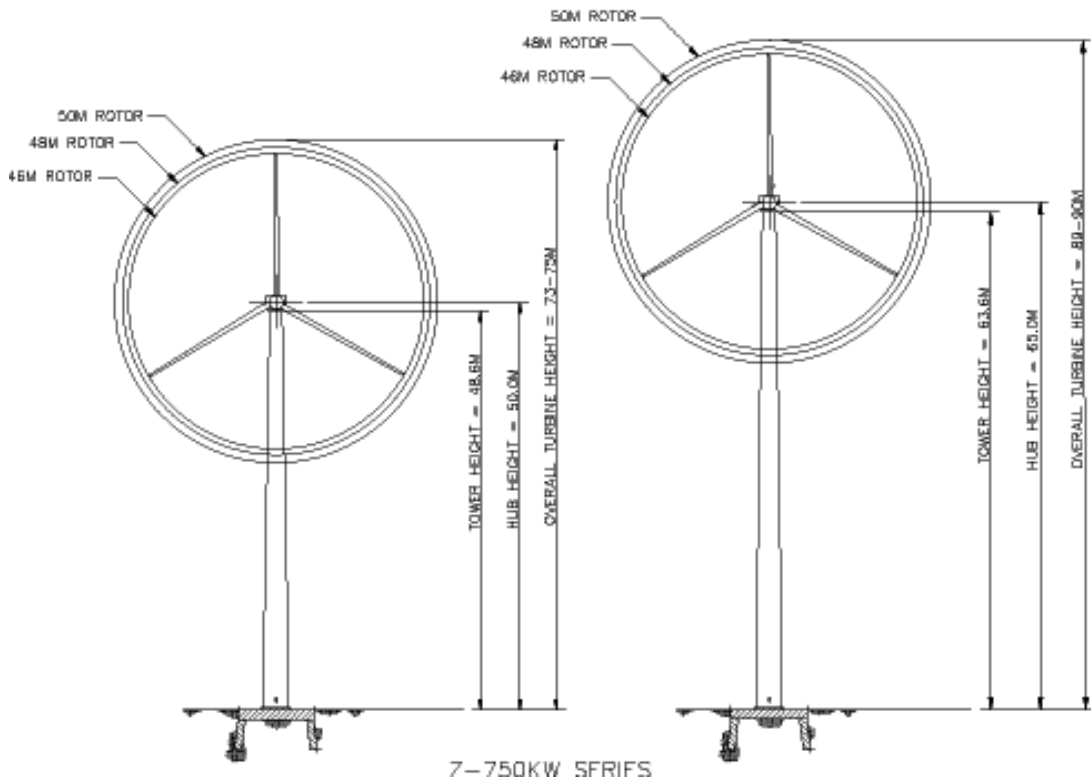

Figure C.1: Tower Heights and Rotor Diameters of the Zond Z-750 Series Wind Turbine Generators - Z-46, Z-48, Z-50[1]

Table C.1: Mass and Material Requirements of Zond Z-46 Wind Turbine Generators					
Mass of Materials^a	Material	lbs/ turbine	Lifetime Tonne/ turbine	Number of turbines	Tonne/ Power Plant
Turbine Blades (85%)	fiberglass	29,100	11.22	143	1,604
Turbine Blades (15%)	ductile iron	29,100	1.98	143	283
Turbine Gear Box - Nacelle	steel	42,600	19.32	143	2,763
Inverter			0.4	143	57
Electrical Wire	copper	3,000	1.36	143	195
Tower	certified steel	124,900	56.64	143	8,100
Foundation	Rebar	20,000	9.07	143	1,297
Foundation	Concrete	830,000	376.41	143	53,826
		1,078,700	476	1,144	68,124

^a Zond reference - Zond Z-40 design from Zond document #00042, Rev. A, Ref. [2]

Table C.2: Mass of Zond Z-46 Wind Turbines at the Buffalo Ridge Phase II Wind Project		
Part	Mass/Turbine	Mass/Power Plant
Nacelle		2,763
Rotor/Blades		1,887
Towers		8,100
Foundations		55,123
Copper - Wire		195
Control Cabinet		57 ^b

^b Estimate, based on control cabinets of BR-I and DePere.

Table C.3: Data for the Transportation of Wind Turbine Components			
<i>Zond Z-46 Nacelle - (Turbine w/o blades)</i>			
Origin/Destination^c	Method	Miles^d	Energy (GJ)
Tehachapi, CA to Lake Benton, MN	Truck	1,785	13,760
Total			13,760
<i>Rotors/Blades</i>			
El Paso, TX to Lake Benton, MN	Truck	1,480	7,793
<i>Towers</i>			
El Paso, TX to Lake Benton, MN	Rail	1,480	4,892
<i>Concrete</i>			
Lake Benton (Batch plant)	Truck	10	1,538
<i>Control Cabinet</i>			
San Francisco, CA to Lake Benton	Truck	1,915	45
Transportation Total (GJ)			28,027

^c Ref. [3]

^d Calculated via Mapquest™, ref. [4]

Table C.4: Lifetime and Annual Energy Investments for a Wind Power Plant (Buffalo Ridge Phase II)			
		Total Energy per Installed GW _e	Annual Energy per GW _{e,y}
Process	Source	GJ/GW_e	GJ/GW_{e,y}
Wind Turbine (embodied)			
Blades	Various	30,302	
Nacelles	Various	95,133	
Inverter		24,261 ^e	
Wiring		25,399	
Tower		278,922	
Foundations		118,844	
Materials Total		572,861	19,095
Transportation			
Blades		7,793	
Nacelles		13,760	
Towers		4,892	
Concrete		1,538	
Control Cabinets		45	
Transportation Totals		28,027	934
Construction			
		91,683 ^f	3,056
Maintenance			
		175,420	5,847
Decommissioning			
		45,842	1,528
Total Required Energy		921,129	30,704

^e Scaled from DePere data by 143/2 ratio (number of turbines)

^f Scaled from BR-I by 143/73 ratio (number of turbines)

Table C.5: Lifetime and Annual Emissions of CO₂ for Buffalo Ridge Phase II Wind Farm

		Total Emissions per Installed 107.25 MW _e	Total Emissions per Installed GW _e	Annual Emissions per GW _e h
Process	Source	Tonne CO₂/plant	Tonne CO₂/GW_e	Tonne CO₂/GWh_e
Wind Turbine (embodied)				
Blades	Various	1,990	18,553	
Nacelles	Various	6,827	63,655	
Inverter		1,523g		
Wiring		1,449		
Tower		20,016		
Foundation		31,188	290,795	
Materials Total		62,992	587,341	6.36
Transportation		2,025	18,877	0.20
Construction		6,623^h	61,749	0.67
Maintenance		12,671	118,146	1.28
Decommissioning		3,311	30,874	0.33
Total Emissions		100,665	938,598	10.17

g Scaled from DePere data by 143/2 ratio (number of turbines)

h Scaled from BR-I by 143/73 ratio (number of turbines)

References – Appendix C

- [1] Enron Wind Corp., “Zond Energy Systems Technical Drawings and Data,” 1 December 1998, Web-site, <http://www.wind.enron.com/zond/drawing.html>.
- [2] Zond Energy Systems, I., “The Z-46 Variable Speed Wind Turbine Generator”, Zond Energy Systems, Inc., Technical Description and Data Report, #00042 Rev. A (5 October 1997).
- [3] Zalay, A., Enron Wind Corporation, Personal Communication, 18 February 1998.
- [4] Mapquest™, “Roadmaps,” 3 February 1998, World-Wide Web, <http://roadmaps.lycos.com/roadmap.html>.

Appendix D - DePere Project

Mass of Materials^a	Material	Lifetime Tonne/ Turbine	Number of Turbines	Tonne/ Power Plant
Turbine Blades	fiberglass	6.0	2	12
Turbine Blades (0%)	ductile iron	0.0	2	0
Turbine Gear Box - Nacelle	steel	33.0	2	66
Inverter		0.3	2	0.6
Electrical Wire ^b	copper	0.8	2	1.6
Tower	certified steel	71.0	2	142
Foundation ^c	Rebar ^d	12.2	2	24
Foundation	Concrete	394.0	2	787
		517.0		1,034

^a From Wisconsin Public Service Corporation fact sheet and web-site, Ref. [1]

^b Ref. [2]

^c Ref. [2]

^d Re-enforcement bar

Part	Mass per Turbine	Mass per Power Plant
Nacelle	33	66
Rotor/Blades	6	12
Towers	71	142
Foundation - Concrete	394	787
Foundation - Rebar	12	24
Copper - Wire	0.8	1.6
Control Cabinet	0.3	0.6
	517	1,034

Table D.3: Data for the Transportation of Wind Turbine Components			
<i>Nacelle - (Turbine w/o blades)</i>			
Origin/Destination^e	Method	Miles^f	Energy (GJ)
Salzbergen to Hamburg, Germany ^g	Rail	160	4
Hamburg to Newark, NJ ^h	Ship	3,800	73
Newark to Shirley, WI	Truck	1,000	184
Total			257
<i>Rotors/Blades</i>			
Huron Park, Ontario to Site	Truck	640	21
<i>Towers</i>			
Morris, MN to Shirley (wind site)	Truck	450	178
<i>Concrete</i>			
DePere to Shirley (wind site)	Truck	10	23
<i>Control Cabinet</i>			
Salzbergen to Hamburg (Germany)	Rail	160	0.04
Hamburg to Montreal, Quebec ⁱ	Ship	3,650	0.64
Montreal to Chicago, IL	Rail	840	0.21
Chicago to Green Bay, WI	Rail	200	0.05
Green Bay to Shirley	Truck	20	0.03
Total			0.29
		Total	479.7

^e Ref.[4].

^f Calculate via MapquestTM, Ref. [5].

^g Distances between German towns were calculated by hand from a German map.

^h Distances between Germany and U.S. reflect distance for airflights as determined by airline ticket booking technologies on www[6]. Distance between Newark, NJ and Hamburg, Germany are roughly based on distance from Newark to Frankfurt (3868 miles).

ⁱ Montreal to Hamburg is sum of flight from Montreal to Amsterdam, Amsterdam to Hamburg (3430 & 237 miles respectively).

	1997\$	I/O Sector^k	Btu/77\$^l	BTU	GJ_{th}/ 2 turbines
Craning	\$75,000	Hoists, cranes	30,233	8.56E+08	903
Labor	\$25,000	Misc. Business Services	10,000	9.44E+07	100
Local Equipment Rental	\$3,000	Construction machinery	34,534	3.91E+07	41
Lodging and Food for Employees	\$8,000	AV1 ^m	28,780	8.69E+07	92
Electrical Grounding	\$12,000	NC, Elect. util.	30,648	1.39E+08	147
					1,283

^j All data from Ref. [7].

^k I/O sector data is from Spreng, Ref. [8].

^l 1997\$ were calculated from the consumer price index by the scale 1977/1997=60.6/160.5=0.3776, Ref. [9].

^m Sector AV1 is an average of the I/O sectors Eat & Drink Places and Hotels.

	1997\$ⁿ	I/O Sector^o	Btu^p	GJ
Foundation Preparation	\$73,000	Ready mix conc.	2.23E+09	2,353
Transformer (2 @ \$10K per)	\$20,000	Transformers	3.22E+08	339
Craning	\$75,000	Hoists, cranes	8.56E+08	903
Labor	\$25,000	Misc. Bus.Serv	9.44E+07	100
Local Equipment Rental	\$3,000	Const. machinry	3.91E+07	41
Lodging and Food for Employees	\$8,000	AV1	8.69E+07	92
Electrical Grounding	\$12,000	NC, Elect. util.	1.39E+08	147
				1,282

ⁿ Ref. [7].

^o See Table 6 for details on Input/Output sectors.

^p Conversion from 1997\$ to 1977\$ was done using the ratio of 1977:1997=60.6:160.5 from the Consumer Price Index, Ref. [9].

Table D.6: Site Specific Construction Direct Energy Consumption (Not Used in Report)^q [10]				
On-site Construction Machinery (Dawes Construction Co.)	Hours	Quantity of Diesel (gal/hr)	Gallons	Energy (GJ)
230 ton Class Crawler Crane	96	7.5	720	106
5 ton Forklift	80	2	160	23
165 ton Hydraulic Crane	42	5	210	31
			1,090	160
Transportation of Construction Equipment	Mass (Tonnes)	Method	Miles^r	Energy (GJ)
Crawler Crane	209	Truck	50	29
Forklift	5	Truck	50	1
Hydraulic Crane	150	Truck	50	21
				51

^q This data was collected, but not used in the report. It is included here for reference only. It was decided that the I/O method of energy analysis should be used instead of the PCA, due to the difficulty of accounting for all energy-consuming processes during construction and assembly.

^r Round Trip – Kaukauna to site (Town of Glenmore)

Table D.7: Electricity Generation Data at the DePere Wind Project

Unit #1						
Interval Ending	Generated KWH	Consumed KWH	Generated KVARH	Consumed KVARH	Amps % THD	Volts % THD
3/31/98	41,503	41.33	-	39,370	4.79	2.46
4/30/98	28,326	1,063	-	1,942	3.21	3.01
5/31/98	-	1,110	-	6,376	0.03	3.08
6/30/98	93	1,041.48	-	421	0.23	3.05
7/31/98	63,059	998	1.80	5,713	9.28	2.98
8/31/98	54,855	327	57.60	5,272	9.29	2.95
9/30/98	29,890	1,200.54	2.40	2,641	26,502	8,854
10/31/98	118,836	237.36	2,027	7,139	19,846	9,078
11/30/98	132,304	364.62	350.40	7,491	16,805	9,280
12/31/98	NA	NA	NA	NA	NA	NA
1998 Totals	468,865	6,382	2,439	76,365	7,020	3,025
Unit #2						
Interval Ending	Generated kWh	Consumed kWh	Generated KVARH	Consumed KVARH	Amps % THD	Volts % THD
3/31/98	45,658	46.32	-	1,213	3.73	2.14
4/30/98	110,962	566.10	121.80	15,879	7.91	3.05
5/31/98	117,475	200.88	236,646	104,354	10.25	3.14
6/30/98	44,747	810.42	655.20	3,502	7.24	3.08
7/31/98	65,663	404.82	1,012	5,491	12.00	3.02
8/31/98	60,243	921.66	1.80	5,081	11.12	2.97
9/30/98	71,375	472.68	5.40	4,987	22,555	8,775
10/31/98	128,709	210.84	2,065.80	6,997	23,933	9,171
11/30/98	139,238	368.28	514.20	7,559	20,062	9,297
12/12/98	NA	NA	NA	NA	NA	NA
1998 Totals	784,071	4,002	241,022	155,062	7,400	3,029

Table D.8: Lifetime and Annual Energy Investments for a Wind Power Plant - (DePere Wind Project)			
		Total Energy per Installed 1.2 MW _e	Annual Energy per GW _{e,y}
Process	Source	GJ_{th}/ Power Plant	GJ_{th}/GW_{e,y}
Wind Turbine (embodied)			
Blades	PCA	154	
Nacelles	PCA	2,273	
Inverter	I/O	339	
Wiring	PCA	209	
Tower	PCA	4,890	
Foundations	PCA	1,925	
Materials Total		9,790	326
Transportation			
	See Table D.3		
Blades		21	1
Nacelles		257	9
Towers		178	6
Concrete		23	
Control Cabinets		0.29	0.01
Transportation Totals		480	15
Construction			
	I/O	1,282.28	43
Maintenances^s			
	I/O -BR1	1,636	55
Decommissioning			
		641	21
Total Required Energy		13,933	464

^s Scaled from BR-I by 2/73 ratio (number of turbines)

Table D.9: Lifetime and Annual Emissions of CO₂ for a Wind Farm (DePere Wind Project)

		Total Emissions per Installed 1.2 MW _e	Total Emissions per Installed GW _e	Annual Emissions per GWh
Process	Source	Tonne CO ₂ /Power Plant	Tonne CO ₂ /GW _e	Tonne CO ₂ /GW _e h
Wind Turbine (embodied)				
Blades	Various	10	8,044	0.15
Nacelles	Various	163	135,915	2.50
Inverter		21	17,751	0.33
Wiring		12	9,928	0.18
Tower		351	292,423	5.38
Foundation		469	391,231	7.20
Materials Totals		1,026	855,292	15.74
Transportation				
Blades		2	1,290	0.02
Nacelles		19	15,473	0.28
Towers		13	10,733	0.20
Control Cabinets		0.02	17	0.00
Transportation Totals		33	27,513	0.5
Construction				
		93	77,186	1.42
Maintenance				
		118	98,455	1.81
Decommissioning				
		46	38,593	0.71
Total Emissions		1,449	1,207,359	22.2

References – Appendix D

- [1] Wisconsin Public Service Corp., “Low Wind Speed Turbine Project, Turbine & Equipment,” 5 September 1998, WWW and public relations fact sheet, www.wisconsinwindproject.com/turbine.html.
- [2] Rast, A., Huron Windpower, Personal Communication, 24 February 1998.
- [3] “Low Wind Speed Turbine Project,” September 5 1998, Web-page, www.wisconsinwindproject.com.
- [4] Rast, A., Huron Windpower, Personal Communication, 3 February 1998.
- [5] Mapquest™, “Roadmaps,” 3 February 1998, World-Wide Web, <http://roadmaps.lycos.com/roadmap.html>.
- [6] Internet Travel Network, “Distance by Air,” 3 February 1998, WWW, www.itn.net.
- [7] Wittholz, H., PH Components, Personal Communication, 17 September 1998.
- [8] Spreng, D.T., *Net Energy Analysis and the Energy Requirements of Energy Systems*. New York: Praeger (1988).
- [9] Bureau of Labor Statistics, “Consumer Price Index - All Urban Consumers,” 13 March 1998, Wide-World Web, <http://146.142.4.24/cgi-bin/surveymost?cu>.
- [10] Jerome, S., Dawes Construction, Kaukauna, WI, Personal Communication, 25 February 1998.